



SIGMADRIVE PM TRACTION

TECHNICAL MANUAL

SK79649-01

© PG Drives Technology 2008

All rights reserved.

This manual is furnished under copyright and may only be used in accordance with the terms laid out by PG Drives Technology.

The information in this manual is furnished for informational use only, is subject to change without notice, and should not be construed as a commitment by PG Drives Technology.

Except as permitted by such terms, no part of this manual may be reproduced, stored in a retrieval system, or transmitted, in any form or by any means electronic, mechanical, recording, or otherwise - without the prior written permission of PG Drives Technology. +44 (0) 1425 27144.

TABLE OF CONTENTS

<p>About this manual.....6</p> <p>Icons6</p> <p>Chapter 1 – Installation.....7</p> <p>1 Introduction.....9</p> <p>2 Guidelines For Working On Electric Vehicles..9</p> <p>2.1 Precautions For Working On Electric Vehicles9</p> <p>2.1.1 Uncontrolled Operation9</p> <p>2.1.2 High Current Arcs9</p> <p>2.1.3 Lead Acid Batteries.....9</p> <p>2.2 Precautions For Use.....9</p> <p>3 Frame Dimensions 10</p> <p>3.1 Small Frame 11</p> <p>3.2 Medium Frame.....12</p> <p>3.3 Large Frame13</p> <p>4 Mounting..... 14</p> <p>4.1 Cable Routing 14</p> <p>5 Wiring Guidance..... 15</p> <p>5.1 Battery and Motor Connections.....16</p> <p>5.1.1 Tightening Torque for Battery and Motor Connections16</p> <p>5.2 Battery and Motor Wire Size and Type Selection17</p> <p>5.3 Battery and Motor Connection Crimps and Tooling.....17</p> <p>5.4 Control Connections17</p> <p>5.5 Control Connection Wiring.....17</p> <p>5.6 Control Connections Crimps and Tooling.....18</p> <p>6 Connections 18</p> <p>6.1 Battery Connection.....18</p> <p>6.1.1 Power Fuse.....18</p> <p>6.1.2 Line Contactor & Pre-charge Resistor18</p> <p>6.1.3 Discharge Resistor.....18</p> <p>6.1.4 Emergency Disconnect Switch18</p> <p>6.2 Motor Connections19</p> <p>6.3 Control Connections19</p> <p>6.4 Connector 'A' – Vehicle Interface (16-way)19</p> <p>Pin 1 – Forward Switch.....19</p> <p>Pin 2 – Reverse Switch.....19</p> <p>Pin 3 – Footswitch / Belly Button.....19</p> <p>Pin 4 – Seat / Tiller.....19</p> <p>Pin 5 – Speed Limit 1 / Inch Forward19</p>	<p>Pin 6 – Speed Limit 2 / Inch Reverse 20</p> <p>Pin 7 – Speed Limit 3 / Handbrake..... 20</p> <p>Pin 8 – Accelerator / Footbrake20</p> <p>Pin 9 – Accelerator / Footbrake20</p> <p>Pin 10 – Keyswitch.....21</p> <p>Pin 11 – Contactor Coil Supply21</p> <p>Pin 12 – Line Contactor.....21</p> <p>Pin 13 – Electric Brake Contactor.....21</p> <p>Pin 14 – Power Steer Contactor21</p> <p>Pin 15 – +12V Supply.....21</p> <p>Pin 16 – +5V Potentiometer Supply21</p> <p>6.5 Connector 'B' – Communications (8-way)21</p> <p>Pin 1 – Not Used.....21</p> <p>Pin 2 – Not Used.....21</p> <p>Pin 3 – Flash Programming Mode (+12V)21</p> <p>Pin 4 – Flash Programmer I/O.....22</p> <p>Pin 5 – CAN L22</p> <p>Pin 6 – CAN H.....22</p> <p>Pin 7 – +12V Supply.....22</p> <p>Pin 8 – 0V22</p> <p>6.6 Connector 'C' – Motor Feedback (6-way)22</p> <p>Pin 1 – Speed Encoder22</p> <p>Pin 2 – Remote LED.....22</p> <p>Pin 3 – Not Used.....22</p> <p>Pin 4 – Thermistor or Steering Potentiometer22</p> <p>Pin 5 – +12V Supply.....22</p> <p>Pin 6 – 0V23</p> <p>7 Electromagnetic Compatibility (E.M.C.).....23</p> <p>7.1 Emissions.....23</p> <p>7.1.1 Power Cables23</p> <p>7.1.2 Signal Cables23</p> <p>7.1.3 Controller23</p> <p>Chapter 2 – Adjustments25</p> <p>1 Adjustments27</p> <p>1.1 Acceleration – (Accel)28</p> <p>1.2 Deceleration – (Decel)28</p> <p>1.3 Creep Speed – (Creep).....28</p> <p>1.4 Maximum Forward Speed – (SpdMaxF)28</p> <p>1.5 Maximum Reverse Speed – (SpdMaxR).....28</p> <p>1.6 Speed Limit 1 / Inching Speed – (Sp1/Inch)28</p> <p>1.7 Speed Limit 2 / Inching Time – (Sp2/Time)28</p> <p>1.8 Speed Limit 3 – (Sp3)29</p>
---	--

1.9	Direction Regen. Braking – (DBrake).....	29	1.7	Power Steering Trigger – (PsF/FR/S).....	47
1.10	Neutral Regen. Braking – (NBrake)	29	1.8	Truck Type Select (Ride/WIK)	47
1.11	Footbrake Regen. Braking – (FBrake)	29	1.9	Not Used	47
1.12	Direction Braking Ramp – (DBrkRamp)	29	1.10	Display Error Indication – (Of/M/M&W).....	48
1.13	Direction Braking End Delay – (DBrkEnd).....	29	1.11	Display Status Field – (Of/DN/K).....	48
1.14	Neutral Braking Ramp – (NBrkRamp).....	30	1.12	Not Used	48
1.15	Neutral Braking End Delay – (NBrkEnd)	30	1.13	Motor Temperature Sensor Type – (MtempTyp).....	48
1.16	Regen Speed – (RegSpd)	30	1.14	Analogue Inputs Set-up – (Accel 8/9)	48
1.17	Maximum Current – (MaxCurr)	30	1.15	Single / Dual Motor Select – (Si/DL/DR)	48
1.18	Battery Voltage – (BattV)	30	1.16	Not Used	49
1.19	Power Steering Delay – (PStrDly)	30	1.17	CAN Node Number – (CAN node).....	49
1.20	Electric Brake Delay – (EBrkDly).....	30			
1.21	Accelerator 0% Voltage – (AccMin)	30	Chapter 5 – Motor Set-up.....	51	
1.22	Accelerator 100% Voltage – (AccMax)	31	1 Motor Set-up	53	
1.23	Footbrake 0% Voltage – (AuxMin).....	31	1.1	Motor Temperature Cutback – (TempStrt).....	54
1.24	Footbrake 100% Voltage – (AuxMax).....	31	1.2	Motor to Vehicle Speed Ratio – (SpdRatio).....	54
1.25	Motor Pot. Min. – (MotMin)	31	1.3	Number of Teeth – (SpdTeeth)	54
1.26	Motor Pot. Max. – (MotMax).....	31	1.4 – 1.29	Not Used	54
1.27	Max. Vehicle Speed – (VmaxSpd)	31	::	Timed Current Limit Explained ::	54
1.28	BDI Reset Level – (BDIreset)	31	1.30	Current Threshold – (CurrTH)	55
1.29	BDI Empty Level – (BDIempty)	32	1.31	Lower Maximum Current – (ImaxLow).....	55
1.30	BDI Warning Level – (BDIwarn)	32	1.32	Threshold Timer – (lthTime)	55
1.31	BDI Cut-out Level – (BDIcut).....	32	1.33 – 1.38	Offset and Gain Settings.....	55
1.32	BDI Speed Limit – (BDIspeed)	32			
1.33	Dual Motor Cutback – (DMcut).....	32	Chapter 6 – Hand-Held Programmer	57	
1.34	Dual Motor Reverse – (DMrev).....	32	1 Introduction	59	
1.35	Dual Motor Speed – (DMspeed)	32	1.1	Interface Switch	59
1.36	Standby Delay – (StdByDly)	33	2 Connection	60	
			2.1	CAN Node Set-up.....	60
Chapter 3 – Diagnostics	35		3 Using the Programmer	60	
1 Error Detection	37		4 Programmer Map	61	
2 Error Codes	38		4.1	Programming, Diagnostic and Test Options	61
3 Status.....	40		4.1.1	Adjustments	61
4 Further Status Information	41		4.1.2	Status	61
5 Test	42		4.1.3	Controller Set-up.....	61
			4.1.4	Motor Set-up	61
Chapter 4 – Controller Set-Up	43		4.1.5	Test	61
1 Controller Set-up	45		4.1.6	About.....	62
1.1	Accelerator Characteristic – (Lin/Curv).....	46	5 Diagnostics	62	
1.2	Not Used	46	6 Software Upgrades	62	
1.3	Proportional Braking – (Bpro/Off).....	46			
1.4	Anti Roll-back (Restraint) – (Arol/Off)	47	Chapter 7 – Sigmagauge.....	63	
1.5	Connector A Pin 5 and 6 – (Spd/Inch)	47	1 Introduction	65	
1.6	Connector A Pin 7 – (Spd3/Hbk).....	47			

1.1	General Information	65
1.1.1	Membrane Buttons	65
1.1.2	Battery Discharge Indicator	65
1.1.3	Fault Indication Field	65
1.1.4	General Indication Field	65
1.1.5	Hours Counter	65
1.1.6	Information Field	65
2	Connection	66
3	Mounting	66
4	Configuring the Sigmagaugage	67
 Chapter 8 – Technical Specifications		69
1	Electrical	71
1.1	Voltage Specifications	71
1.2	Current Specifications	71
2	Environmental	71
3	Mechanical	72

About this manual

This manual is divided into 8 chapters.

Chapter 1 – Installation

This chapter deals with the mounting, connection and wiring of the Sigmadrive.

Chapter 2 – Adjustments

This chapter deals with the Sigmadrive's 'Adjustments' parameters.

Chapter 3 – Diagnostics

This chapter provides an overview of the diagnostic capabilities of the Sigmadrive range.

Chapter 4 – Controller Set-up

This chapter deals with the Sigmadrive's 'Controller Set-up' parameters.

Chapter 5 – Motor Set-up

This chapter deals with the Sigmadrive's 'Motor Set-up' parameters.

Chapter 6 – Hand-held Programmer

This chapter provides an overview of the Sigmadrive Hand-held Programmer.

Chapter 7 – Sigmagauge

This chapter provides an overview of the Sigmagauge.

Chapter 8 – Technical Specifications

This chapter provides a summary of the Sigmadrive's Technical Specifications.

Icons

Throughout this manual, icons are used to draw the reader's attention.

The icons used are:



Note – A general point for best practice.



Caution – A point of safety which if ignored could result in damage to the control system or the vehicle.



Warning – A point of safety which if ignored could cause injury to the individual.

PG Drives Technology accepts no liability for any losses of any kind if these points are not followed.



CHAPTER I - INSTALLATION

I Introduction

The Sigmadrive is an advanced digital controller for all popular motor types and is designed for electric vehicle applications such as Industrial Trucks, Personnel Carriers, Golf Cars, Aerial Work Platforms and Materials Handling Equipment.

Advanced drive algorithms are employed to ensure smooth, accurate, predictable and efficient control of vehicle speed and torque. Motor reversing and regenerative braking in both directions is achieved via solid-state electronics.

The Sigmadrive has been designed to easily withstand the harsh operating environments that electric vehicles typically endure. State-of-the-art construction techniques ensure the controller can withstand shock, vibration and extremes of temperature. To ensure the Sigmadrive installation is as robust as possible, follow the guidelines in this manual.

2 Guidelines For Working On Electric Vehicles

2.1 Precautions For Working On Electric Vehicles

Working on any electrical system can be dangerous. Work on electric vehicles should only be undertaken by skilled or supervised persons, in a segregated location that eliminates the risk of injury to other persons. Before performing any kind of work on electric vehicles, ensure that the following basic safety advice is followed.

2.1.1 Uncontrolled Operation

Fault conditions or programming changes may cause the motor to run out of control. Disconnect the motor or raise the drive wheels above the ground. If lifting the vehicle, use the correct jacking procedure as recommended by the vehicle manufacturer to lift the vehicle's drive wheels clear of the ground. Once lifted, fit axle stands to safely support the vehicle and remove the jack. Ensure that all such lifting equipment is in serviceable condition and suitable for the vehicle in question.

2.1.2 High Current Arcs

Batteries contain very high levels of energy and can be extremely dangerous if mishandled or abused. Always disconnect the batteries before working on the vehicle's electrical system and the motor controller wiring. Remove all jewellery from wrist and fingers and use properly insulated tools to prevent shorts. Wear safety glasses at all times.

2.1.3 Lead Acid Batteries

Charging or discharging lead acid batteries generates hydrogen gas, which can build up in and around the battery area. Ensure charging is performed in a ventilated area. Follow the battery manufacturer's safety recommendations. Wear safety glasses at all times.

2.2 Precautions For Use

Do not drive the vehicle:

- Beyond restrictions indicated in your vehicle user manual, for example inclines, curb heights etc.
- In places or on surfaces where a loss of wheel grip could be hazardous, for example on wet grassy slopes.
- If you know that the controller or other crucial components require repair.



Although the controller is designed to be extremely reliable and each unit is rigorously tested during manufacture, the possibility of system malfunction always exists (however small the probability). Under some conditions of system malfunction the controller must (for safety reasons), stop the vehicle instantaneously. If there is any possibility of the user falling out of the vehicle as a result of a sudden braking action, it is imperative that a restraining device such as a seat belt is supplied with the vehicle and that it is in use at all times when the vehicle is in motion. PGDT accept no liability for losses of any kind arising from the unexpected stopping of the vehicle, or arising from the improper use of the vehicle or controller.



Do not operate the controller if the vehicle behaves erratically, or shows abnormal signs of heating, sparks or smoke. Turn the controller off at once and consult your service agent. PGDT accepts no liability for losses of any kind arising from failure to comply with this condition.



Electronic equipment can be affected by Electro Magnetic Interference (EMI). Such interference may be generated by radio stations, TV stations, other radio transmitters and cellular phones. If the vehicle exhibits erratic behavior due to EMI, turn the controller off immediately and consult your service agent. PGDT accepts no liability for losses of any kind arising from failure to comply with this condition.



It is the responsibility of the vehicle manufacturer to ensure that the vehicle complies with appropriate National and International EMC legislation. PGDT accepts no liability for losses of any kind arising from failure to comply with this condition.



The vehicle user must comply with all vehicle safety warnings. PGDT accepts no liability for losses of any kind arising from failure to comply with this condition.

3 Frame Dimensions

The Sigmadrive is constructed in three frame sizes – small, medium and large. This can be identified from the last character of the product code. For example, PMT425S is a Small frame size.

3.1 Small Frame

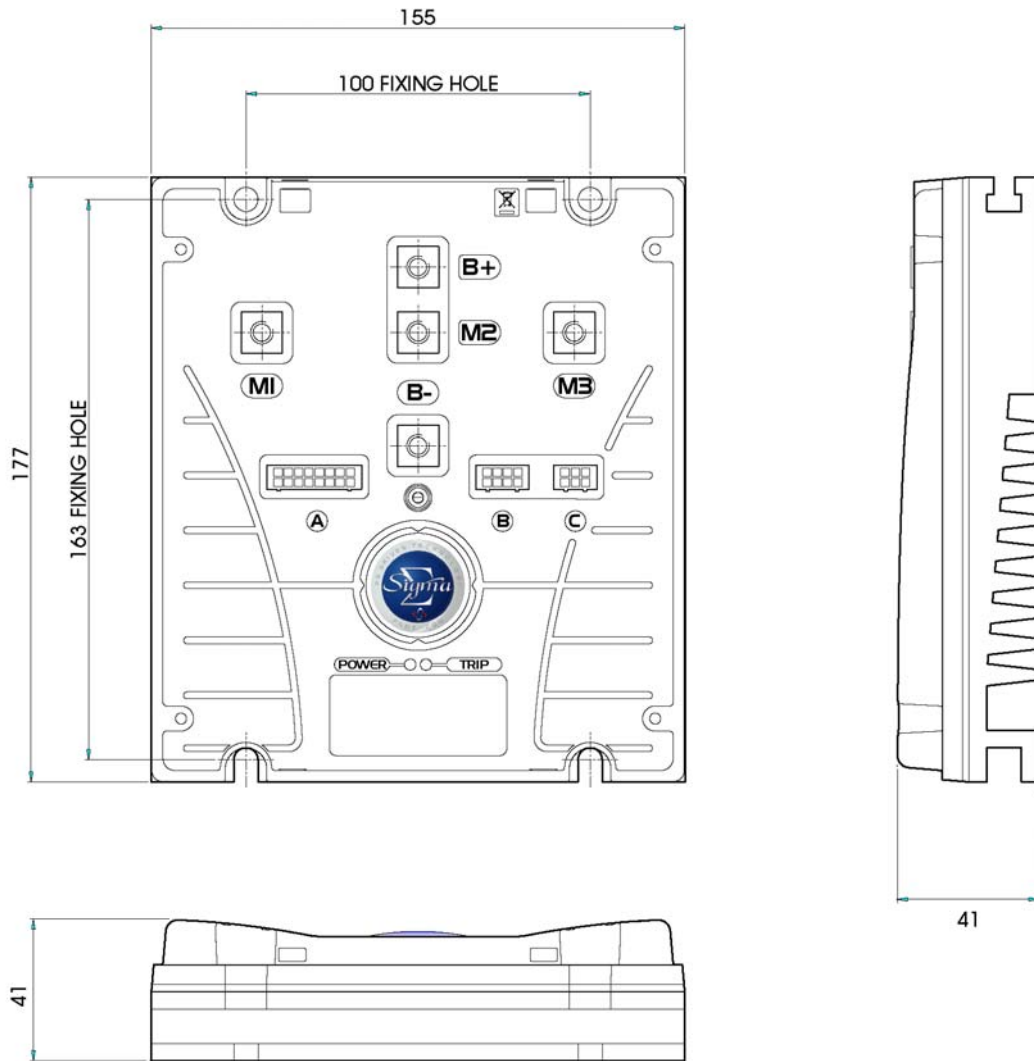

3.2 Medium Frame

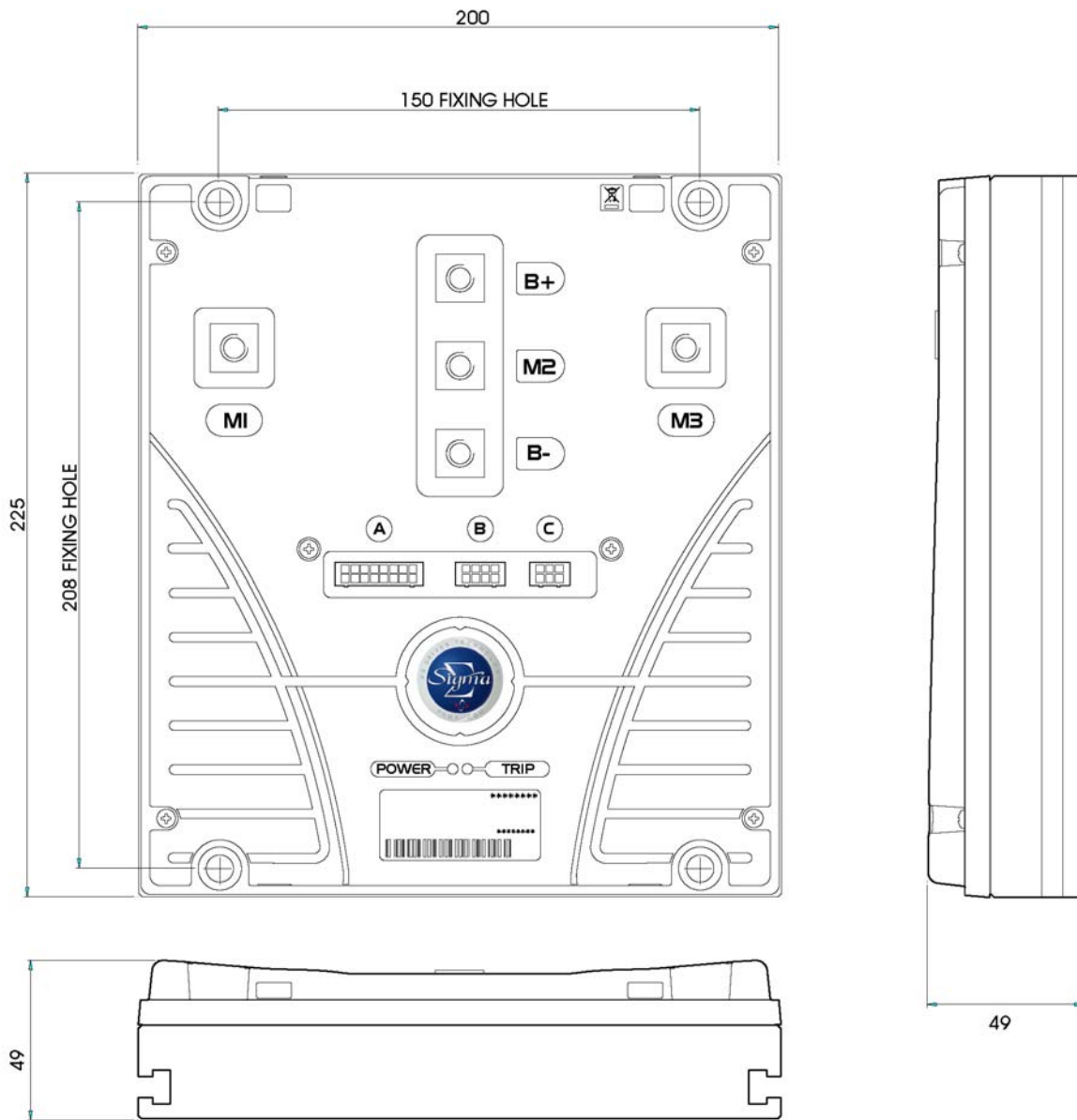

3.3 Large Frame

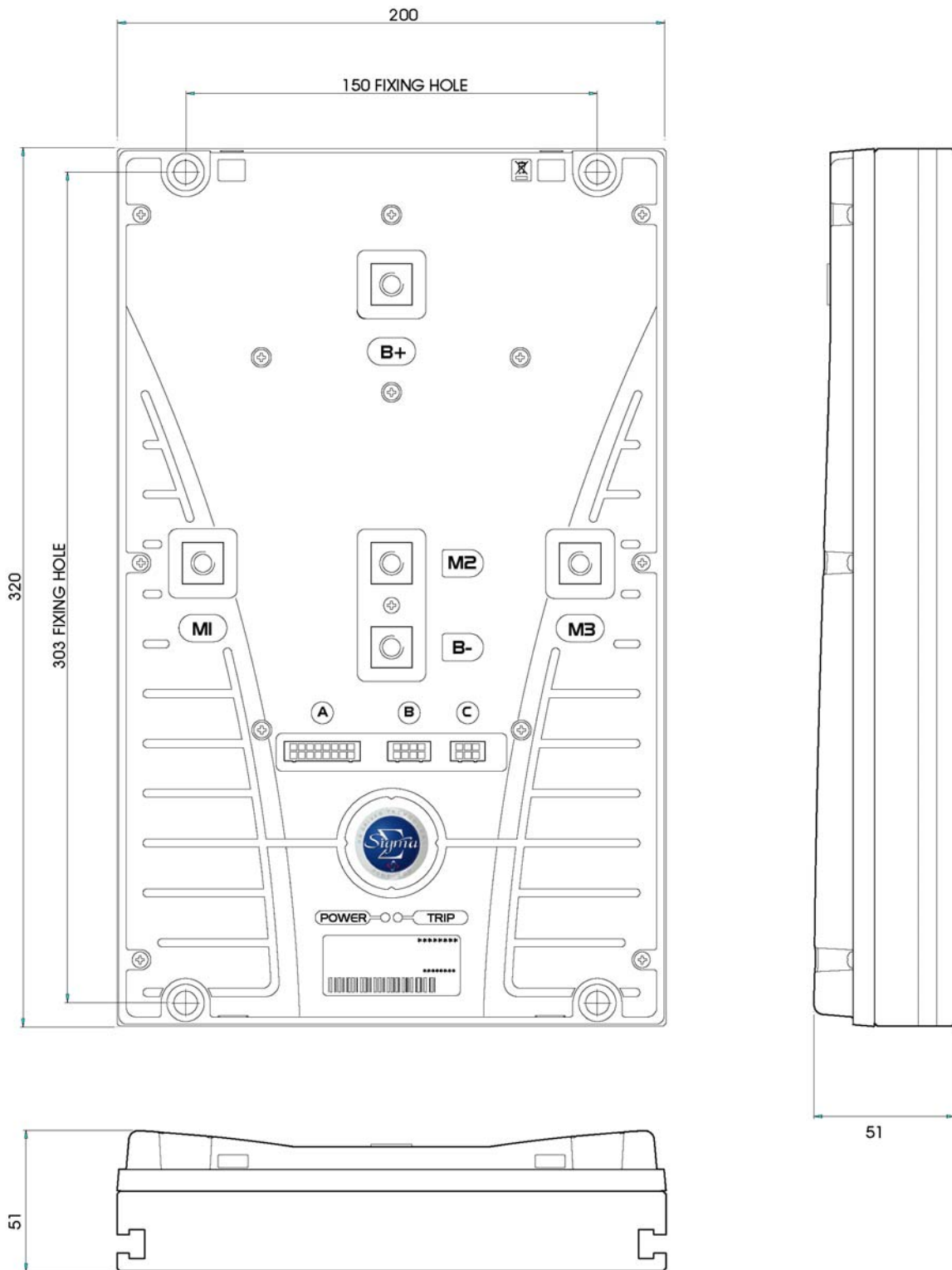

4 Mounting

Careful consideration should be given to the location chosen to mount the controller. Although the Sigmadrive benefits from excellent environmental protection, it is good engineering practice for the selected position to be clean and dry, to minimize shock, vibration, temperature changes and exposure to water & contaminants.

If vertical orientation mounting is not possible, then a cover should be used to shield the controller. Cables must be routed to prevent liquids flowing into the connections. The mounting position should also allow access to all connections and allow the connection and removal of a programming device.

Secure the controller to the vehicle via the four clearance holes provided. Ideally, a flat clean metal surface will provide maximum heat dissipation and ensure full rated power output. Failure to use all four mounting points may result in a loss in performance. Any airflow around the controller will further enhance the thermal performance. If desired, the controller's thermal performance may be further improved by applying a silicone-free thermal compound between the baseplate and the machine chassis.

The Small Frame controller has M6 (1/4") clearance holes.

The Medium and Large Frame controllers have M8 (5/16") clearance holes.



Under strenuous driving conditions, it is possible for metal sections of the controller's case to exceed 41°C (106 °F). Under such conditions, the machine manufacturer should ensure that either the user cannot touch these surfaces, or that the user is warned not to touch these surfaces. While 41°C (106 °F) is very close to normal body temperature, prolonged contact with surfaces above 41°C (106 °F) can result in burns to the skin. PGDT accepts no liability for losses of any kind arising from failure to comply with this condition.

4.1 Cable Routing

The cables to the controller must be routed and secured in such a way as to prevent damage, for example by chafing or crushing, or exposure to solvents or other chemicals that may degrade the insulation. It is suggested that the cables are mounted so that they loop up to the controller, therefore minimizing the flow of moisture into the connectors. Route wiring to keep lengths as short as possible, especially the high current motor and battery cabling.

5 Wiring Guidance

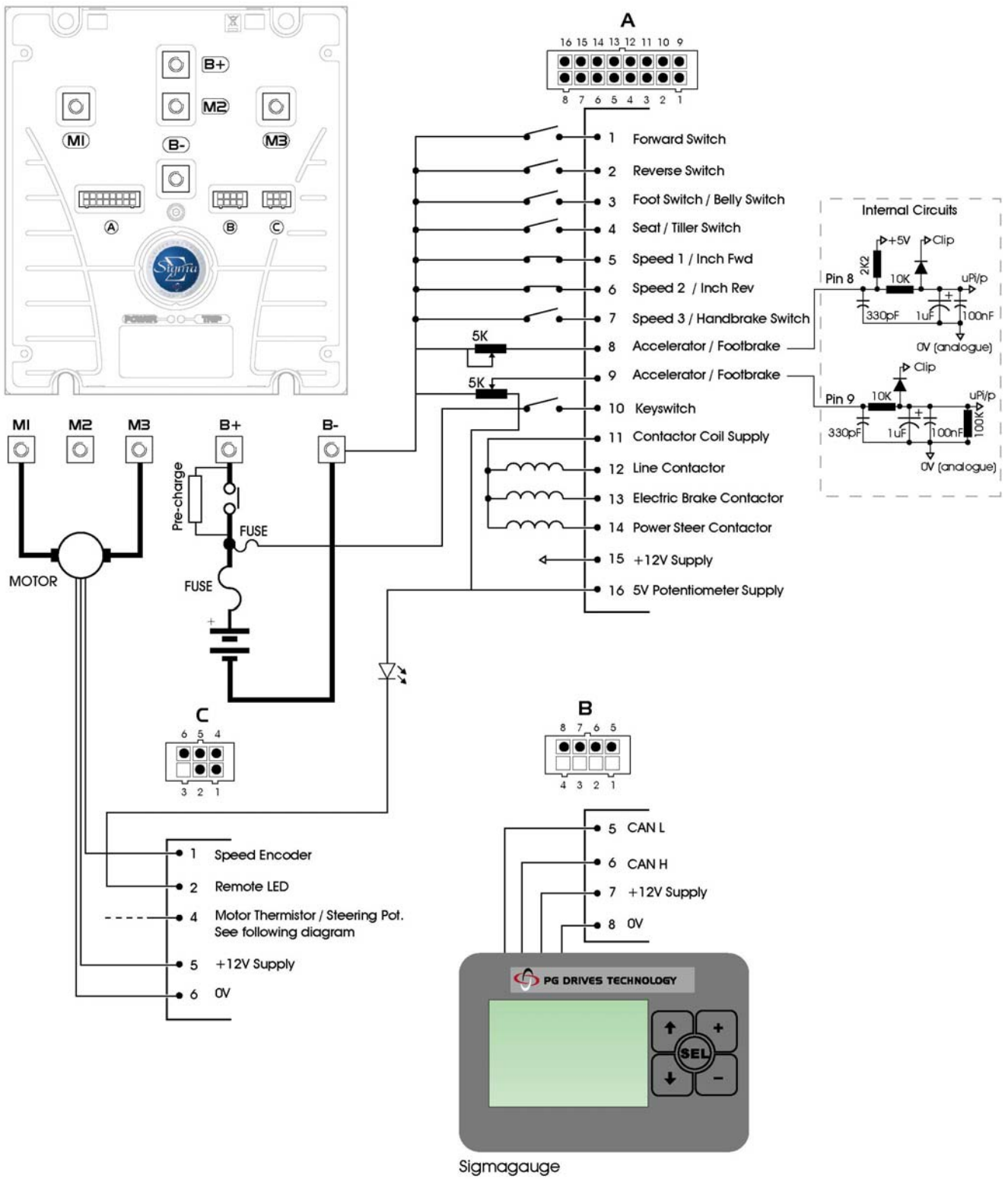

Steering Potentiometer Wiring

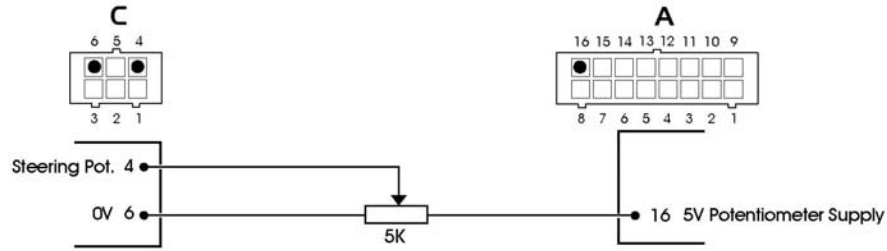

Motor Thermistor Wiring

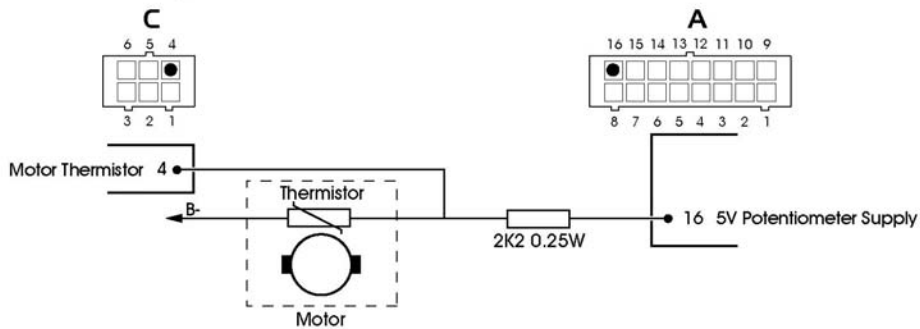

5.1 Battery and Motor Connections

Five copper terminals with threaded holes are provided for the high current connections. These are identified as B+, B-, M1, M2 and M3. The controller is provided with suitable screws, spring washers and flat washers for fastening the battery and motor cables. PGDT recommends the arrangement of screw, spring washer and flat washer as shown below for the correct termination of the high power connectors.

The small frame size has M6 threaded holes, while the medium and large frame sizes have M8 threaded holes.

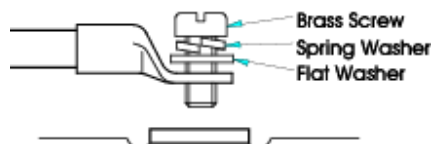

! If alternate screws or bolts are used, it is essential that the thread insertion depth is less than 14mm. Damage to the controller may occur if this depth is exceeded.

! After securely fitting the high current cables, do not put undue upward pressure on them by twisting or pulling – this may result in damage to the terminal pillars. If the cable position needs to be readjusted, loosen the screw and washer arrangement first.

5.1.1 Tightening Torque for Battery and Motor Connections

The medium and large frame sizes use M8 screws and these should be tightened to 11Nm.

The small frame size uses M6 screws and these should be tightened to 9Nm.

5.2 Battery and Motor Wire Size and Type Selection

The wiring arrangement used on a particular vehicle can greatly affect the current carrying capacities of individual wires. Ambient temperature, grouping and wire length can all significantly de-rate cable performance and other factors such as vehicle duty cycles and airflow should also be taken into consideration when selecting vehicle wiring.

PGDT recommends the use of BS6231 (UL 1015, 1028, 1283 or 1284 dependent on wire gauge), Tri-rated wire due to its superior flexibility and 90/105°C temperature rating. The table below shows the minimum recommended wire sizes for the Motor and Battery connections on the Sigmadrive controllers.

Frame Size	Motor	Battery
Small	16 mm ²	16 mm ²
Medium	35 mm ²	35 mm ²
Large	70 mm ²	70 mm ²



It is the responsibility of the vehicle manufacturer to ensure that the vehicle's wiring arrangement is suitable for the intended application, and complies with all necessary standards that are dictated by the relevant approvals of regulatory organizations. PGDT accepts no liability for losses of any kind arising from an inappropriate wiring arrangement.

5.3 Battery and Motor Connection Crimps and Tooling

Good quality crimping is essential in ensuring the long-term reliability of the vehicle's electrical system. Poor quality crimps may initially appear satisfactory, but can deteriorate over time, ultimately causing the vehicle to break down. For the battery and motor connections, the use of AMP® AMPower III™ or Solistrand™ copper tube leg terminals is recommended. It is absolutely vital that the selected crimp terminal is designed to be used with the wire size and type being used.

It is also vital that for the selected crimp terminal the correct tooling is used for its installation onto the wire, and that the procedure for doing so is followed correctly. Contact the crimp terminal manufacturer to ensure that the tooling employed is suitable for use with the chosen combination of wire and crimp terminal.

If insulated crimps are used, ensure the insulation is firmly pushed into place. If uninsulated crimps are used, it is recommended that heatshrink or similar sleeving is used to insulate the barrel of the crimp terminal.



Ensure that only fully trained and skilled operators perform the crimping procedure and that the instructions provided by the crimp terminal manufacturer are followed. PGDT accepts no liability for losses of any kind if the recommendations made in this section are not followed.

5.4 Control Connections

The low current control connections on the Sigmadrive are via Molex® SMD Micro Fit 3.0 Series connectors. These connectors are labeled as A, B and C on the cover of the controller and provide the following functions.

- A 16-way Vehicle Interface Connector
- B 8-way Communications Connector
- C 6-way Motor Feedback Connector

5.5 Control Connection Wiring

Use 0.5mm²/18AWG wire gauge for all control connections. It is also recommended that Tri-rated wire with a 105°C insulation rating is used.

5.6 Control Connections Crimps and Tooling

The following table shows the Molex part numbers for the mating crimps, housings, crimp tool and extraction tool.

Alternatively, the mating connectors can be purchased directly from PGDT using the connector kit part numbers shown.

Connector	PGDT Connector Kit Part No.	Molex Housing Part No.	Molex Crimp Part No.	Molex Crimp Tool Part No.	Molex Extraction Tool Part No.
A – 16-way	D51066	43025-1600	43030-0007	69008-0982	11-03-0043
B – 8-way	D51068	43025-0800	43030-0007		
C – 6-way	D51067	43025-0600	43030-0007		



PGDT recommends that only genuine Molex parts should be used. Inferior quality crimps or incorrect tooling can seriously reduce the reliability and longevity of the controller or vehicle. PGDT accepts no liability for losses of any kind if non-recommended parts are used.

6 Connections

6.1 Battery Connection

Connect the positive supply to the B+ terminal and the negative supply to the B- terminal.

6.1.1 Power Fuse

A suitable fuse must be fitted to the battery positive supply. This fuse should be fitted as closely as possible to the battery's positive terminal.

6.1.2 Line Contactor & Pre-charge Resistor

A suitable line contactor must be connected to the battery positive supply. This should be fitted with a 5W 10kΩ pre-charge resistor connected in parallel across the contacts. The coil of the line contactor can be controlled by the Sigmadrive, via pin 12 of Connector A.

6.1.3 Discharge Resistor

Units manufactured before October 2008 require an external discharge resistor. The resistor should be fitted between the Sigmadrive's B+ and B- terminals. The correct value for each controller model is shown below.

24V only Sigmadrive – 10kΩ 1/4W

24V – 48V Sigmadrive – 22kΩ 1/4W

72V – 80V Sigmadrive – 47kΩ 1/4W

6.1.4 Emergency Disconnect Switch

For certain vehicle types, safety legislation requires that an emergency battery disconnect switch or switches should be fitted in the battery positive supply, in order to allow complete isolation of the vehicle's electrical system from the battery. The location of this switch or switches should be as stipulated in the appropriate legislative documentation.



It is the responsibility of the vehicle manufacturer to ensure appropriate fuses, line contactors and emergency disconnect switches are used and that these devices are appropriately located. PGDT accepts no liability for losses of any kind if inappropriate devices or arrangements are used.

6.2 Motor Connections

The motor should be connected between the M1 terminal and the M3 terminal of the controller. The M2 terminal remains unconnected. If, when a forward command is applied, the vehicle drives in reverse, swap the motor wires.

6.3 Control Connections

The control connections are via three connectors with pin-outs as follows.

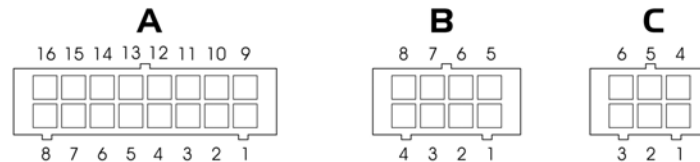

Connector A: Vehicle Interface

Connector B: Communications to display module and/or programmer

Connector C: Motor Feedback

Details of the functions of each of the pins for these connectors are shown in the following section.

6.4 Connector 'A' – Vehicle Interface (16-way)

Pin 1 – Forward Switch

This switch must be closed in conjunction with the Accelerator to give a forward drive signal.

Pin 2 – Reverse Switch

This switch must be closed in conjunction with the Accelerator to give a reverse drive signal.

Pin 3 – Footswitch / Belly Button

The function of this input is set by the programmable parameter, 3.8 Truck Type Select.

If set to Ride, then the vehicle's Footswitch should be connected to this pin, and must be closed to allow drive.

If set to Wlk, then the vehicle's Belly Button switch should be connected to this pin. When the Belly Button switch is closed, the vehicle will drive in the opposite direction for 1.5s.

Pin 4 – Seat / Tiller

The function of this input is to provide a general safety interlock. This could be a Seat switch on a ride-on vehicle, a Tiller switch on a "walkie" vehicle or a general deadman's trigger on other vehicle types. The switch must be closed to allow drive.

Pin 5 – Speed Limit 1 / Inch Forward

The function of this input is set by the programmable parameter, 3.5 Connector A Pin 5 and 6.

If set to Spd, then this input can be used to limit the speed of the vehicle to a value set by the programmable parameter, 1.6 Speed Limit 1. The speed limit will occur when the switch is open.

If set to Inch, then this input is used to "inch" the vehicle in the forward direction. Inching will occur when the switch is closed. The exact functionality of inching is set by the programmable parameters, 1.6 Inching Speed and 1.7 Inching Time.

Pin 6 – Speed Limit 2 / Inch Reverse

The function of this input is set by the programmable parameter, 3.5 Connector A Pin 5 and 6.

If set to Spd, then this input can be used to limit the speed of the vehicle to a value set by the programmable parameter, 1.7 Speed Limit 2. The speed limit will occur when the switch is open.

If set to Inch, then this input is used to “inch” the vehicle in the reverse direction. Inching will occur when the switch is closed. The exact functionality of inching is set by the programmable parameters, 1.6 Inching Speed and 1.7 Inching Time.

Pin 7 – Speed Limit 3 / Handbrake

This input is primarily intended to be used with a handbrake switch, however, its function can be set by the programmable parameter, 3.6 Connector A Pin 7.

If set to Spd3, then this input can be used to limit the speed of the vehicle to a value set by the programmable parameter, 1.8 Speed Limit 3. The speed limit will occur when the switch is open.

If set to Hbk, then this input should be connected to the vehicle’s handbrake switch. When the switch is closed, i.e. the handbrake is on, the vehicle’s speed will be as set by the programmable parameter, 1.8 Speed Limit 3.

Pin 8 – Accelerator / Footbrake

This is an analogue input that will accept a 2-wire 5kΩ potentiometer or a 0V to 5V voltage signal.

The function of this input is set by the programmable parameter, 3.14 Analogue Inputs Set-up.

If set to 0, then this input should be connected to the vehicle’s Accelerator device.

If set to 1, then this input should be connected to the vehicle’s Footbrake device.

When set to 0, the active range of the accelerator input is defined by the programmable parameters, 1.21 Accelerator 0% Voltage and 1.22 Accelerator 100% Voltage. The former parameter sets the voltage that relates to zero drive demand from the Accelerator, while the latter parameter sets the voltage that relates to 100% drive demand from the Accelerator.

When set to 1, the active range of the footbrake input is defined by the programmable parameters, 1.23 Footbrake 0% Voltage and 1.24 Footbrake 100% Voltage. The former parameter sets the voltage that relates to zero braking demand from the Footbrake, while the latter parameter sets the voltage that relates to 100% braking demand from the Footbrake.

If a Footbrake switch is used on the brake pedal instead of an analogue device, the switch should connect this input to the voltage corresponding to the value of parameter, 1.24 Footbrake 100% Voltage, in order to effect full braking.

Pin 9 – Accelerator / Footbrake

This is an analogue input that will accept a 3-wire 5kΩ potentiometer or a 0V to 5V voltage signal.

The function of this input is set by the programmable parameter, 3.14 Analogue Inputs Set-up.

If set to 0, then this input should be connected to the vehicle’s Footbrake device.

If set to 1, then this input should be connected to the vehicle’s Accelerator device.

When set to 0, the active range of the footbrake input is defined by the programmable parameters, 1.23 Footbrake 0% Voltage and 1.24 Footbrake 100% Voltage. The former parameter sets the voltage that relates to zero braking demand from the Footbrake, while the latter parameter sets the voltage that relates to 100% braking demand from the Footbrake.

If a Footbrake switch is used on the brake pedal instead of an analogue device, the switch should connect this input to the voltage corresponding to the value of parameter, 1.24 Footbrake 100% Voltage, in order to effect full braking.

When set to 1, the active range of the accelerator input is defined by the programmable parameters, 1.21 Accelerator 0% Voltage and 1.22 Accelerator 100% Voltage. The former parameter sets the voltage that relates to zero drive demand from the Accelerator, while the latter parameter sets the voltage that relates to 100% drive demand from the Accelerator.

Pin 10 – Keyswitch

This input should be connected to the switched side of the keyswitch. The other side of the keyswitch should be connected to the battery positive supply.

A fuse of sufficient value to supply all contactor coil currents should be connected between the battery positive supply and the keyswitch. The position of the fuse should be as close as possible to the tap-off point for the keyswitch supply.

Pin 11 – Contactor Coil Supply

This output is the positive supply to the vehicle's contactors. The voltage level of this supply corresponds to the vehicle's battery voltage. The maximum supply current from this pin is 3A.

Pin 12 – Line Contactor

This pin should be connected to the negative side of the Line Contactor coil. The Sigmadrive will control the Line Contactor as required. The maximum rating for this connection is 3A and it is fully protected for use with inductive loads.

Pin 13 – Electric Brake Contactor

This pin should be connected to the negative side of the Braking Contactor coil. The Sigmadrive will control the Braking Contactor as required. The maximum rating for this connection is 3A and it is fully protected for use with inductive loads.

Pin 14 – Power Steer Contactor

This pin should be connected to the negative side of the Power Steer Contactor coil. The Sigmadrive will control the Power Steer Contactor as required. The maximum rating for this connection is 3A and it is fully protected for use with inductive loads.



An external contactor driver is required when using pin 14 on small frame Sigmadrive controllers. Please contact PGDT for further information if a Power Steer Contactor is required for this size of Sigmadrive.

Pin 15 – +12V Supply

A 12V supply. The maximum supply current is 20mA from this pin.

Pin 16 – +5V Potentiometer Supply

A supply for the 5k Ω Accelerator or Footbrake potentiometer connected to pin 9 and the remote LED connected to pin 2 of Connector C (if fitted).

6.5 Connector 'B' – Communications (8-way)**Pin 1 – Not Used**

Not used.

Pin 2 – Not Used

Not used.

Pin 3 – Flash Programming Mode (+12V)

For use with the Flash Programmer.

Pin 4 – Flash Programmer I/O

For use with the Flash Programmer.

Pin 5 – CAN L

CAN Low communications line to the Programming Device, Display or other Controller(s).

Pin 6 – CAN H

CAN High communications line to the Programming Device, Display or other Controller(s).

Pin 7 – +12V Supply

A 12V supply. The maximum supply current is 20mA from this pin.

Pin 8 – 0V

A 0V supply for the Programming Device or Display.

6.6 Connector 'C' – Motor Feedback (6-way)**Pin 1 – Speed Encoder**

Connect to the speed signal of the motor encoder.

Pin 2 – Remote LED

This output can be connected, via pin 16 of Connector A, to an external fault indication LED.

If an error is detected during operation, the external fault indicator will flash synchronously with the Sigmadrive's integral red diagnostic LED.

Pin 3 – Not Used

Not used.

Pin 4 – Thermistor or Steering Potentiometer

The function of this input is set by the programmable parameter, 3.15 Single / Dual Motor Select, in the Controller Set-up menu.

If set to 0 (Motor Temperature), then this input can be connected to an external thermistor, typically on the motor, which can be used to reduce controller current output with respect to temperature. The type of thermistor is set by the parameter, 3.13 Motor Temperature Sensor Type. Once the correct sensor type has been set, the parameter, 4.1 Motor Temperature Cutback, can then be used to set the temperature at which current foldback will begin.

If set to either 1 (Dual Motor Left) or 2 (Dual Motor Right), then this input can be connected to a 3-wire 5k Ω potentiometer that measures the steering angle of the vehicle. The potentiometer should be connected to a 5V supply – a convenient connection point can be found on pin 16 of Connector A.

The active range of the input when used by a steering potentiometer is defined by the parameters, 1.25 Motor Pot. Min. and 1.26 Motor Pot. Max. 1.25 Motor Pot. Min. sets the voltage that relates to the minimum (full left hand lock) steering angle, while 1.26 Motor Pot. Max. sets the voltage that relates to the maximum (full right hand lock) steering angle.

Pin 5 – +12V Supply

A 12V supply with a maximum current of 20mA. This output can be used for the motor encoder supply.

Pin 6 – OV

A OV connection point for the Speed Encoder and Steering Potentiometer.



Avoid routing the 6-way motor feedback cables close to the motor power cables - they must not be tie-wrapped together. If screened cable is used, contact PGDT for details on how to connect this at the motor and controller ends. This is critical to help avoid any noise or incorrect speed measurement issues.

7 Electromagnetic Compatibility (E.M.C.)

You should consider EMC and perform relevant tests as early as possible in the design phase.

7.1 Emissions

Any high-speed switch is capable of generating harmonics at frequencies that are many multiples of its basic operating frequency. It is the objective of a good installation to contain or absorb the resultant emissions. All wiring is capable of acting as a receiving or transmitting antenna. Wiring should be arranged to take maximum advantage of the structural metal work inherent in most vehicles. Vehicle metalwork should be electrically linked with conductive braids.

7.1.1 Power Cables

All cables should be routed within the vehicle framework and kept as low in the structure as is practical; a cable run within a main chassis member is better screened from the environment than one routed through or adjacent to an overhead guard. Power cables should be kept short to minimize emitting and receiving surfaces. Shielding by the structure may not always be sufficient; cables run through metal shrouds may be required to contain emissions.

Parallel runs of cables in common circuits can serve to cancel emissions, e.g. the battery positive and negative cables following similar paths.

Tie all cables into a fixed layout and do not deviate from the approved layout in production vehicles. A re-routed battery cable could negate any approvals obtained.

7.1.2 Signal Cables

All wiring harnesses should be kept short. Wiring should be routed close to the vehicle metalwork. All signal wires should be kept clear of power cables or made from screened cable. This is particularly important if the control wiring carries analogue information, e.g. Accelerator wiring. Tie all wiring securely and ensure it always follows the same layout.

7.1.3 Controller

Thermal and EMC (emissive) requirements tend to work in opposition. Additional insulation between the controller assembly and the vehicle framework reduces capacitive coupling and hence emissions but tends to reduce the thermal performance. A working balance needs to be established by experiment. The complete installation should be documented in detail and faithfully reproduced on all production vehicles. When making changes, consider their effect on compliance, ahead of other factors such as cost reduction.



CHAPTER 2 – ADJUSTMENTS

I Adjustments

The Sigmadrive Programmer 'Adjustments' menu (1. Adjustments), contains the parameters shown in the table below. Each parameter has a unique reference number, 1.x, as shown in the left-hand column. The parameter name as it appears on the Programmer screen and parameter range are also shown.

Ref.	Parameter	Programmer Text	Range
1.1	Acceleration	Accel	0.1s – 10.0s
1.2	Deceleration	Decel	0.1s – 10.0s
1.3	Creep Speed	Creep	0% – 25%
1.4	Maximum Forward Speed	SpdMaxF	0% – 100%
1.5	Maximum Reverse Speed	SpdMaxR	0% – 100%
1.6	Speed Limit 1	Sp1	0% – 100%
	Inching Speed	Inch	0% – 25%
1.7	Speed Limit 2	Sp2	0% – 100%
	Inching Time	Time	0.1s – 10.0s
1.8	Speed Limit 3	Sp3	0% – 100%
1.9	Direction Regen. Braking	DBrake	50A – Unit max.
1.10	Neutral Regen. Braking	NBrake	50A – Unit max.
1.11	Footbrake Regen Braking	FBrake	50A – Unit max.
1.12	Direction Braking Ramp	DBrkRamp	0.1s – 10.0s
1.13	Direction Braking End Delay	DBrkEnd	0.1s – 10.0s
1.14	Neutral Braking Ramp	NBrkRamp	0.1s – 10.0s
1.15	Neutral Braking End Delay	NBrkEnd	0.1s – 10.0s
1.16	Regen Speed	RegSpd	0% – 100%
1.17	Maximum Current	MaxCurr	10A – Unit max.
1.18	Battery Voltage	BattV	24V – Unit max.
1.19	Power Steering Delay	PStrDly	0s – 50s
1.20	Electric Brake Delay	EBrkDly	0s – 50s
1.21	Accelerator 0% Voltage	AccMin	0V – 5V
1.22	Accelerator 100% Voltage	AccMax	0V – 5V
1.23	Footbrake 0% Voltage	AuxMin	0V – 5V
1.24	Footbrake 100% Voltage	AuxMax	0V – 5V
1.25	Motor Pot. Min.	MotMin	0V – 5V
1.26	Motor Pot. Max.	MotMax	0V – 5V
1.27	Max. Vehicle Speed	VmaxSpd	0 kph – 100 kph
1.28	BDI Reset Level	BDIreset	18V – 125% Bat. V
1.29	BDI Empty Level	BDIempty	12V – 125% Bat. V
1.30	BDI Warning Level	BDIwarn	0% – 99%
1.31	BDI Cut-out Level	BDIcut	0% – 99%
1.32	BDI Speed Limit	BDIspeed	0% – 100%
1.33	Dual Motor Cutback	DMcut	0% – 100%
1.34	Dual Motor Reverse	DMrev	0% – 100%
1.35	Dual Motor Speed	DMspeed	0% – 100%
1.36	Standby Delay	StdByDly	0 min (off) – 10 min

I.1 Acceleration – (Accel)

This sets the time taken to accelerate from zero speed to maximum speed.

The maximum speed demand is set by 1.4 Maximum Forward Speed and 1.5 Maximum Reverse Speed.

Increasing the value results in a slower vehicle acceleration, while decreasing the value results in a faster vehicle acceleration.

The adjustable range is 0.1s to 10.0s in 0.1s steps.

I.2 Deceleration – (Decel)

This sets the time taken to decelerate from maximum speed to zero speed.

Increasing the value results in a slower vehicle deceleration, while decreasing the value results in a faster vehicle deceleration.

The adjustable range is 0.1s to 10.0s in 0.1s steps.

I.3 Creep Speed – (Creep)

This effectively sets the initial speed that the vehicle will adopt on entering drive.

Increasing the value will help minimise any delay from selecting drive to creeping the vehicle.

The adjustable range is 0% to 25% in 1% steps.

I.4 Maximum Forward Speed – (SpdMaxF)

This sets the maximum forward speed of the vehicle.

The adjustable range is 0% to 100% in 1% steps.

I.5 Maximum Reverse Speed – (SpdMaxR)

This sets the maximum reverse speed of the vehicle.

The adjustable range is 0% to 100% in 1% steps.

I.6 Speed Limit 1 / Inching Speed – (Spl/Inch)

The function of this parameter is dependent on the setting of, 3.5 Connector A Pin 5 and 6, in the Controller Set-up menu. That parameter sets whether pins 5 and 6 are used as speed limiting inputs or as inching control inputs.

If set to 0, then Speed Limit 1 sets the maximum speed of the vehicle when a switch connected to pin 5 on Connector A is open. The speed limit is not applied when the switch is closed or a lower speed limit is in operation.

The adjustable range is between 0% and 100% in 1% steps.

If set to 1, then Inching Speed sets the speed of the vehicle (in both directions), that will be active when a switch connected to pin 5 or pin 6 of Connector A is closed. The vehicle will not inch when the switch is open.

The adjustable range is 0% to 25% in 1% steps.

I.7 Speed Limit 2 / Inching Time – (Sp2/Time)

The function of this parameter is dependent on the setting of, 3.5 Connector A Pin 5 and 6, in the Controller Set-up menu. That parameter sets whether pins 5 and 6 are used as speed limiting inputs or as inching control inputs.

If set to 0, then Speed Limit 2 sets the maximum speed of the vehicle when a switch connected to pin 6 on Connector A is open. The speed limit is not applied when the switch is closed or a lower speed limit is in operation.

The adjustable range is between 0% and 100% in 1% steps.

If set to 1, then Inching Time sets the period (in both directions), the vehicle will be moving for, when a switch connected to pin 5 or pin 6 of Connector A is closed. The vehicle will not inch when the switch is open.

The adjustable range is 0.1s to 10s in 0.1s steps.



For ease of adjustment, this parameter should be set to 0% before programming 3.5 Connector A Pin 5 and 6 to 'Inching'.

I.8 Speed Limit 3 – (Sp3)

The function of this parameter is dependent on the setting of, 3.6 Connector A Pin 7, in the Controller Set-up menu.

If set to 0, then Speed Limit 3 sets the maximum speed of the vehicle when a switch connected to Pin 7 on Connector A is open. The speed limit is not applied when the switch is closed or a lower speed limit is in operation.

If set to 1, then Speed Limit 3 sets the maximum speed of the vehicle when a switch connected to Pin 7 on Connector A is closed. The speed limit is not applied when the switch is open or a lower speed limit is in operation. Please note, that even if this parameter is set to 0%, the controller will continue to pulse whilst the Foot Switch is closed. This is designed to avoid rollback on gradients.

The adjustable range is 0% to 100% in 1% steps.

I.9 Direction Regen. Braking – (DBrake)

This sets the maximum level of current used for braking, upon a direction change.

The adjustable range is 50A to the maximum controller current in 10A steps.

I.10 Neutral Regen. Braking – (NBrake)

This sets the maximum level of current used for braking, when the vehicle is in neutral, i.e. no drive signal in either direction.

The adjustable range is 50A to the maximum controller current in 10A steps.

I.11 Footbrake Regen. Braking – (FBrake)

This sets the maximum level of current used for braking, when the brake pedal is fully operated, i.e. the voltage from the footbrake potentiometer is equal to the setting of the parameter, 1.24 Footbrake 100% Voltage.

The adjustable range is 50A, to the maximum controller current in 10A steps.

The Footbrake Regen. Current is proportional to the brake pedal from 0A to this value.

I.12 Direction Braking Ramp – (DBrkRamp)

This sets the time taken to ramp down from maximum speed in the current direction to zero, upon a change of direction. After passing through zero speed, the normal acceleration time as described in 1.1 Acceleration, applies. Increasing the value gives a smoother but longer transition to zero speed.

The regenerative current during braking is limited by 1.9 Direction Regen. Braking. When this level is reached, the direction braking ramp time is prolonged until the regenerative current falls below the maximum current level. At this point, the ramp time takes over again.

The adjustable range is 0.1s to 10s in 0.1s steps.

I.13 Direction Braking End Delay – (DBrkEnd)

This setting allows a time to hold the vehicle at zero speed when 1.12 Direction Braking Ramp time has passed.

The value set by this parameter is ignored during Belly Button and Inching operation.

The adjustable range is 0.1s to 10.0s in 0.1s steps.

I.14 Neutral Braking Ramp – (NBrkRamp)

This sets the time taken to ramp down from maximum speed to zero, when the vehicle enters neutral, i.e. no drive signal in either direction. Increasing the value gives a smoother but longer transition to zero speed.

The regenerative current during braking is limited by 1.10 Neutral Regen. Braking. When this level is reached, the neutral braking ramp time is prolonged until the regenerative current falls below the maximum current level. At this point, the ramp time takes over again.

The adjustable range is 0.1s to 10s in 0.1s steps.

I.15 Neutral Braking End Delay – (NBrkEnd)

This setting is normally associated with a Walkie-type vehicle fitted with an electromechanical brake connected to pin 13 on Connector A. This setting allows a time to hold the vehicle at zero speed when the 1.14 Neutral Braking Ramp time has passed. It is usually used in conjunction with the parameter 1.20 Electric Brake Delay to operate the electromechanical brake.

The value set by this parameter is ignored during Belly Button and Inching operation.

The adjustable range is 0.1s to 10.0s in 0.1s steps.

I.16 Regen Speed – (RegSpd)

This sets the minimum speed a vehicle has to reach in order for the braking end delay functionality to operate.

The adjustable range is 0% to 100% in steps of 1%.

I.17 Maximum Current – (MaxCurr)

This sets the maximum current limit during driving.

The adjustable range is 10A to the maximum rating of the controller in 10A steps.

I.18 Battery Voltage – (BattV)

This should be set to the nominal battery voltage of the system.

Whenever the battery voltage is equal to or less than this value, the BDI on the Sigmagauge will start to decrease.

The adjustable range is 24V to the maximum rating of the controller in 2V steps.

I.19 Power Steering Delay – (PStrDly)

This sets the period that the Power Steer Contactor input, pin 14 on Connector A, will remain active after the trigger source has been removed. The trigger source is as set by the parameter, 3.7 Power Steering Trigger, in the Controller Set-up menu.

The adjustable range is 0s to 50s in 0.1s steps.

I.20 Electric Brake Delay – (EBrkDly)

This setting is normally associated with a Walkie-type vehicle fitted with an electromechanical brake connected to pin 13 on Connector A. The value sets the delay before the electric brake is applied, after the vehicle has ramped down to zero speed.

The adjustable range is 0s to 50s in 0.1s steps.

I.21 Accelerator 0% Voltage – (AccMin)

This sets the voltage on the Accelerator input that will correspond to zero speed.

The adjustable range is 0V to 5V in 0.1V steps.

The Accelerator input can be configured via the parameter, 3.14 Analogue Inputs Set-up, in the Controller Set-up menu.

I.22 Accelerator 100% Voltage – (AccMax)

This sets the voltage on the Accelerator input that will correspond to maximum speed.

The adjustable range is 0V to 5V in 0.1V steps.

The Accelerator input can be configured via the parameter, 3.14 Analogue Inputs Set-up, in the Controller Set-up menu.

I.23 Footbrake 0% Voltage – (AuxMin)

This sets the voltage on the Footbrake input that will correspond to zero braking force.

The adjustable range is 0V to 5V in 0.1V steps.

The Footbrake input can be configured via the parameter, 3.14 Analogue Inputs Set-up, in the Controller Set-up menu.

I.24 Footbrake 100% Voltage – (AuxMax)

This sets the voltage on the Footbrake input that will correspond to the braking force as set by the parameter, 1.11 Footbrake Regen Braking.

The adjustable range is 0V to 5V in 0.1V steps.

The Footbrake input can be configured via the parameter, 3.14 Analogue Inputs Set-up, in the Controller Set-up menu.

I.25 Motor Pot. Min. – (MotMin)

The operation of this parameter is dependent on the setting of 3.15 Single / Dual Motor Select, in the Controller Set-up menu. If that parameter is set to 0 (motor temperature), then this setting has no effect.

If it is set to 1 or 2 (dual motor left or dual motor right), then this parameter sets the voltage on the Steering Pot input, pin 4 of Connector C, which will correspond to the minimum steering angle. By convention, the minimum steering angle relates to the full left hand lock of the vehicle.

The adjustable range is 0V to 5V in 0.1V steps.

I.26 Motor Pot. Max. – (MotMax)

The operation of this parameter is dependent on the setting of 3.15 Single / Dual Motor Select, in the Controller Set-up menu. If that parameter is set to 0 (motor temperature), then this setting has no effect.

If it is set to 1 or 2 (dual motor left or dual motor right), then this parameter sets the voltage on the Steering Pot Input, pin 4 of Connector C, which will correspond to the maximum steering angle. By convention, the maximum steering angle relates to the full right hand lock of the vehicle.

The adjustable range is 0V to 5V in 0.1V steps.

I.27 Max. Vehicle Speed – (VmaxSpd)

This sets the maximum value that is indicated on the Sigmagauge LCD when the vehicle is driving at maximum speed. To calibrate this value to the output from the encoder, set the parameter, 4.2 Motor to Vehicle Speed Ratio, in the Motor Set-up menu.

The adjustable range is 0kph to 100kph in 1kph steps.

Setting the parameter to 0kph means that there will be no indication of speed shown on the Sigmagauge LCD.

I.28 BDI Reset Level – (BDIreset)

This sets the voltage at which the BDI will reset to show a 100% charged battery on the Sigmagauge. This setting only has an effect at power-up.

The adjustable range is 18V to 125% of the nominal operating voltage of the controller in 0.1V steps.

1.29 BDI Empty Level – (BDIempty)

This sets the 0% charge level for the BDI. Whenever the battery voltage is equal to or less than 1.18 Battery Voltage, the BDI on the Sigmagauge will start to decrease.

The adjustable range is 12V to 125% of the nominal operating voltage of the controller in 0.1V steps.

1.30 BDI Warning Level – (BDIwarn)

This sets the level of battery charge at which the BDI warning icon on the Sigmagauge will start to flash. The value is set as a percentage of battery charge. 100% battery charge corresponds to the voltage set by the parameter, 1.28 BDI Reset Level and 0% battery charge corresponds to the voltage set by the parameter, 1.29 BDI Empty Level.

The adjustable range is 0% to 99% in 1% steps.

1.31 BDI Cut-out Level – (BDIcut)

This sets the level of battery charge at which the speed of the vehicle will be limited to a value set by the parameter, 1.32 BDI Speed Limit. The cut-out value is set as a percentage of battery charge. 100% battery charge corresponds to the voltage set by the parameter, 1.28 BDI Reset Level and 0% battery charge corresponds to a level set by the parameter, 1.29 BDI Empty Level.

The adjustable range is 0% to 99% in 1% steps.

1.32 BDI Speed Limit – (BDIspeed)

This sets the maximum speed of the vehicle if the BDI level is below the value set by the parameter, 1.31 BDI Cut Out Level.

The adjustable range is 0% to 100% in 1% steps.

1.33 Dual Motor Cutback – (DMcut)**1.34 Dual Motor Reverse – (DMrev)****1.35 Dual Motor Speed – (DMspeed)**

For these functions to be active, the parameter, 3.15 Single / Dual Motor Select, in the Controller Set-up menu, must be set to 1 or 2.

The value for 1.33 Dual Motor Cutback is expressed as a percentage where:

100% = a voltage corresponding to the parameter, 1.26 Motor Pot. Max. (normally full right hand lock).

-100% = a voltage corresponding to the parameter 1.25 Motor Pot. Min. (normally full left hand lock).

0% = a voltage midway between the above two.

1.33 Dual Motor Cutback sets the point at which the inner motor starts to reduce speed in response to the position of the steering potentiometer. For example, if a value of 10% is chosen, the speed reduction will commence if the steering potentiometer is outside of a central deadband of +/- 10%.

1.34 Dual Motor Reverse sets the point at which the inner motor starts to reverse in response to the position of the steering potentiometer. For example, if a value of 70% is chosen, the inner motor will begin to reverse at steering angles of + or - 70%.

1.35 Dual Motor Speed sets the maximum reverse speed of the inner motor and outer wheel, i.e. when the vehicle has reached the maximum turning angle.

The speed of the motor while turning is scaled as follows:

In the central deadband, the inner motor speed is equal to the outer motor speed and corresponds to the driving speed of the vehicle.

In the zone between 1.33 Dual Motor Cutback and 1.34 Dual Motor Reverse, the speed of the inner motor will be linearly scaled between the driving speed of the vehicle and zero.

In the zone between 1.34 Dual Motor Reverse and the full turning angle, i.e. +/- 100%, the speed of the inner motor will be linearly scaled between zero and the value set by 1.35 Dual Motor Speed.

In the zone between 1.33 Dual Motor Cutback and the full turning angle, i.e. +/- 100%, the speed of the outer motor will be linearly scaled between the driving speed and the value set by 1.35 Dual Motor Speed.

The parameters, 1.33 Dual Motor Cutback, 1.34 Dual Motor Reverse and 1.35 Dual Motor Speed have an adjustable range of 0% to 100% in 1% steps.

Example:

A vehicle is fitted with a 5k Ω steering potentiometer that reaches 1k Ω at full left lock and 4k Ω at full right lock. The mechanical angle between the two points is 270°, i.e. 135° each side of centre. The steering potentiometer supply voltage is 5V.

If the vehicle has a steering angle of less than +/- 15° from centre, then both drive wheels should be driven at the same speed.

If the steering angle is greater than +/- 15° from centre, the speed of the inner wheel should start to reduce. This reduction should continue until an angle of +/- 100°, at which point the inner wheel should be at zero speed.

If the steering angle is increased further, then the inner wheel should start to drive in reverse until the full steering lock is reached, when the speed of the inner wheel should be 25% (in the reverse direction) of the outer wheel.

1. Determine which controller will be the left hand unit and which will be the right hand unit, then set 3.15 Single / Dual Motor Select accordingly.
2. Set the parameters, 1.25 Motor Pot. Min. and 1.26 Motor Pot. Max.
 At the full left hand position, the steering potentiometer voltage = $(1\text{k}\Omega / 5\text{k}\Omega) \times 5\text{V} = 1\text{V}$.
 At the full right hand position, the steering potentiometer voltage = $(4\text{k}\Omega / 5\text{k}\Omega) \times 5\text{V} = 4\text{V}$.
 These voltages can also be checked and set using the Programmer's 'Test' menu (see Diagnostics chapter).
3. Set the parameter 1.33 Dual Motor Cutback.
 The steering angle from centre to either lock is 135° and it is not required to start reducing the inner motor speed until 15°. The percentage of full lock at which speed reduction will commence = $(15^\circ / 135^\circ) \times 100 = 11\%$.
 A combination of practical testing, observation and use of the Programmer's 'Status' and 'Test' menus is recommended for each application.
4. Set the parameter, 1.34 Dual Motor Reverse.
 The inner wheel should be at zero speed when the steering angle is 100°. This expressed as a percentage of full lock = $(100^\circ / 135^\circ) \times 100 = 74\%$.
 A combination of practical testing, observation and use of the Programmer's 'Status' and 'Test' menus is recommended for each application.
5. Set the parameter, 1.35 Dual Motor Speed.
 Simply set this value to the maximum permitted speed of the inner wheel, in this case 25%, when it is driving in the opposite direction to that selected.

1.36 Standby Delay – (StdByDly)

This sets a period of time after which the Line Contactor will be de-energised if there is no drive activity and the seat or tiller switch is open. When the seat or tiller switch is closed, the controller powers up, performs all necessary hardware and software checks and closes the line contactor.

The adjustable range is 0 min to 10 min in 0.5 min steps.



CHAPTER 3 – DIAGNOSTICS

I Error Detection

If the controller detects an error, it can be displayed in up to five different ways.

Firstly, the red LED on the controller itself will flash. The number of flashes in the sequence will reflect the error code.

In addition, an external LED or fault indication device can be connected to the Sigmadrive, which will flash synchronously with the red LED.

The error code can also be read by the Programmer. It will be displayed as a number (preceded by 'F'), on the right-hand side of the Controller Type screen as shown below.

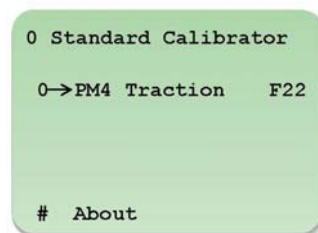

























The Programmer's Status menu also allows both the current and previous error codes to be viewed. See section, Status, for more details.

Lastly, the Sigmagauge display can signal an error, using specific icons. Refer to the Sigmagauge chapter for further details.

2 Error Codes



Once the error type has been noted, refer to the following table to identify the cause. If the error persists after taking the suggested action, contact your Service Agent.

Code / LED Flashes	Sigmagaugae Icon	Cause / Action
Warning Error		
0 / On		Controller is functioning.
1		Handbrake switch closed. Release Handbrake.
2		Not used.
3		Not used.
4		Battery voltage 'becoming' too high. Reduce braking levels or vehicle speed.
5		Thermal foldback. Allow motor to cool, operate vehicle within specification.
5		Motor brushes worn out. Replace brushes.
6		Controller over-temperature. Allow controller to cool and check drive train.
7		Out-of-Range programming. Check all parameters are within permitted limits.
8		Default settings restored after re-flash. Cycle power.
Main Error – Recycle to Neutral		
9		Internal memory error. Contact Service Agent.
10		Direction selection error - both Fwd and Rev selected. Check direction switch operation and connections.
11		Seat or Tiller switch not closed. Check switch operation and connections.
12		Sequence error - the Footswitch or Direction switch is operated at power-up. Check switch operation and connections.
13		Accelerator deflected at power-up. Check Accelerator operation and connections.
14		Ride-on - forbidden input selected (Fwd, Rev, FS, Seat, Handbrake), when inching the vehicle. Walkie - drive is attempted without releasing the belly switch after time-out period has passed.
15		Battery voltage too low. Charge battery or check its condition and connections.
16		Not used.
17		Not used.
18		High-side MOSFET error in neutral or while pulsing. Check motor insulation and line contactor. If error persists, contact Service Agent.









19		Low-side MOSFET error while pulsing. Check motor insulation. If error persists, contact Service Agent.
20		Motor over-current. Check programming of motor parameters.
		Hard Error – Recycle Key-switch
21		Contactor coil error. Check contactor coil(s) and connections.
22		Battery voltage too high. Reduce braking levels or speed.
23		Low-side MOSFET error in neutral. Check motor insulation and line contactor. If error persists, contact Service Agent.
24		Controller error or line contactor coil error. Check line contactor coil. If error persists, contact Service Agent.
25		Contactor error. Check coil(s) & contacts.
26		Controller error. Contact Service Agent.
27		Low-side MOSFET error before line contactor has closed. Check motor insulation and line contactor. If error persists, contact Service Agent.
28		Not used.
29		Not used.
30		Not used.

3 Status

The Programmer's Status menu shows a live-readout of parameter values. This is extremely useful when fine-tuning the system or carrying out diagnostic work. The table below gives details of the parameters that may be viewed.

Some of the menu items have additional functions that can be accessed via the  and  buttons. The options that display recorded minimum and maximum values relate to the lifetime of the controller.

The functions, 2.9 Motor Demand and 2.10 Motor %on, also display further status information. This information is displayed in place of the usual units shown on the screen. See Further Status Information for more details.

Ref.	Parameter	Programmer Text	Steps/Units	Notes
2.1	Drive Hours Counter  Key Hours Counter	Drive	0.1Hrs	
2.2	Error Log  Time of Error	Fault		Last recorded error code. Measured in Key Hours.
2.3	Battery Discharge Indicator	BDI	1%	
2.4	Vehicle Speed	Vehicle	1kph	
2.5	Battery Voltage  Maximum Voltage	Battery	0.5V	
2.6	Controller Temperature  Minimum Temperature  Maximum Temperature	Control+	1°C	
2.7	Steering Angle Motor Temperature  Minimum Temperature  Maximum Temperature	Steer M+	1% 1°C	Units displayed as % or °C.
2.8	Accelerator  Auxiliary Input	Accel	1%	Actual input from Accelerator. Actual input from Auxiliary input.
2.9	Motor Demand *	Demand	1%on	Expressed as % of FET 'on' time.
2.10	Motor %on *	Motor	1%on	Actual motor %on allows the duty cycle of the PWM to be deduced.
2.11	Motor Voltage	Motor	0.5V	
2.12	Motor Current**	Motor +	10A	+ = Drive Current, - = Brake Current.
2.13	Not Used	- n/a -		
2.14	Motor Speed RPM	Speed	RPM	
2.15	Not Used	- n/a -		
2.16	Not Used	- n/a -		
2.17	Capacitor (Bridge) Voltage	Cap	0.5V	
2.18	M1 Voltage	M1	0.1V	
2.19	Not Used	- n/a -		
2.20	M3 Voltage	M3	0.1V	
2.21	PGDT Use Only			
2.22	PGDT Use Only			
2.23	PGDT Use Only			
2.24	PGDT Use Only			

*See section, Further Status Information.

**The use of a current clamp or similar measuring device is recommended at lower levels.

4 Further Status Information

The status information, 2.9 Motor Demand, also relays some operational status data about the controller. This is in the form of a two-letter abbreviation that replaces the '%on' on the Programmer's screen. These abbreviations are listed below.

Neut:	Neutral, i.e. no drive demand and controller is not pulsing.
Fdrv:	Forward Drive, i.e. controller is applying forward drive to the motor.
FdrL:	Forward Drive Left controller in dual motor configuration.
FdrR:	Forward Drive Right controller in dual motor configuration.
Rdrv:	Reverse Drive, i.e. controller is applying reverse drive to the motor.
RdrL:	Reverse Drive Left controller in dual motor configuration.
RdrR:	Reverse Drive Right controller in dual motor configuration.
Dbrc:	Direction Braking, i.e. the controller is braking as the result of a direction change.
Nbrk:	Neutral Braking, i.e. the controller is braking as a result of a neutral drive demand.
Fbrk:	Footbraking, i.e. the controller is braking as a result of the Footbrake being operated.
Abrk:	Anti Roll-back active.
Fxx:	Error Code, where 'xx' denotes the specific error.

The status information, 2.10 Motor %on, also relays some controller limit indication data. Again, this is in the form of a two-letter abbreviation that replaces the '%on' on the Programmer's screen. These abbreviations are listed below.

SM:	Maximum Speed, i.e. maximum speed is available, no limits or interlocks active.
S1:	Speed Limit 1 is active.
S2:	Speed Limit 2 is active.
S3:	Speed Limit 3 is active.
S4:	Not used.
S5:	Not used.
S6:	Not used.
SI:	Inching Speed is being applied.
SB:	BDI Speed Limit is being applied.
SD:	Dual Motor Speed Limit is being applied.
CL:	Current Limit, i.e. the controller is in drive current limit mode.
BL:	Brake Current Limit, i.e. the controller is in braking current limit mode.
CT:	Controller Temperature, i.e. the controller has reduced its output due to a high heatsink temperature.
MT:	Motor Temperature, i.e. the controller has reduced its output due to a high motor temperature.

5 Test

The Programmer's Test menu allows a live-readout of the controller's inputs and outputs. This is extremely useful when carrying out diagnostic work. The table below gives details of the inputs and outputs that may be viewed.

Ref.	Function	Input/Output	Display Format
5.1	Forward Switch	Conn. A pin 1	0/1 0 = Open, 1 = Closed
5.2	Reverse Switch	Conn. A pin 2	0/1 0 = Open, 1 = Closed
5.3	Footswitch / Belly Button	Conn. A pin 3	0/1 0 = Open, 1 = Closed
5.4	Seat Switch / Tiller Switch	Conn. A pin 4	0/1 0 = Open, 1 = Closed
5.5	Speed Limit 1 / Inch Forward	Conn. A pin 5	0/1 0 = Open, 1 = Closed
5.6	Speed Limit 2 / Inch Reverse	Conn. A pin 6	0/1 0 = Open, 1 = Closed
5.7	Speed Limit 3 / Handbrake	Conn. A pin 7	0/1 0 = Open, 1 = Closed
5.8	Footbrake Switch	Conn. A pin 8/9	0/1 0 = Open, 1 = Closed
5.9	Accelerator (%)	Conn. A pin 8/9	0% to 100%
5.10	Accelerator (V)	Conn. A pin 8/9	0V to 5.1V
5.11	Footbrake (%)	Conn. A pin 8/9	0% to 100%
5.12	Footbrake (V)	Conn. A pin 8/9	0V to 5.1V
5.13	Thermistor / Steering Pot. (%)	Conn. C pin 4	0% to 100%
5.14	Thermistor / Steering Pot. (V)	Conn. C pin 4	0V to 5.1V
5.15	Line Contactor	Conn. A pin 12	0/1 0 = 0V, 1 = Vbatt.
5.16	Electric Brake Contactor	Conn. A pin 13	0/1 0 = 0V, 1 = Vbatt.
5.17	Power Steer Contactor	Conn. A pin 14	0/1 0 = 0V, 1 = Vbatt.
5.18	Speed Encoder	Conn. C pin 1	0/1 0 = 0V, 1 = 5V
5.19	Red Remote LED	Conn. C pin 2	0/1 0 = 0V, 1 = 5V
5.20	Not used		Reserved For Future Use
5.21	Red LED		0/1 0 = Off, 1 = On
5.22	Green LED		0/1 0 = Off, 1 = On
5.23	Contactor Feedback		0/1 0 = Off, 1 = On
5.24	12V		0/1 0=12V Internal Rail Low, 1 = 12V OK



CHAPTER 4 – CONTROLLER SET-UP

I Controller Set-up

The Sigmadrive Programmer 'Controller Set-up' menu (3. Controller Set-up), contains the parameters shown in the table below. Each parameter has a unique reference number, 3.x, as shown in the left-hand column. The right-hand column shows the parameter name as it appears on the Programmer screen.

Ref.	Parameter	Programmer Text
3.1	Accelerator Characteristic	Lin/Curv
3.2	Not Used	Spd/Torq
3.3	Proportional Braking	Bpro/Off
3.4	Anti Roll-back (Restraint)	Arol/Off
3.5	Connector A Pin 5 and 6	Spd/Inch
3.6	Connector A Pin 7	Spd3/Hbk
3.7	Power Steering Trigger	PsF/FR/S
3.8	Truck Type Select	Ride/Wlk
3.9	Not Used	Key/Drv
3.10	Display Error Indication	Of/M/M&W
3.11	Display Status Field	Of/D/V/K
3.12	Not Used	InitDisp
3.13	Motor Temperature Sensor Type	MTempTyp
3.14	Analogue Inputs Set-up	Accel 8/9
3.15	Single / Dual Motor Select	Si/DL/DR
3.16	Not Used	- n/a -
3.17	CAN Node Number	CAN node

I.1 Accelerator Characteristic – (Lin/Curv)

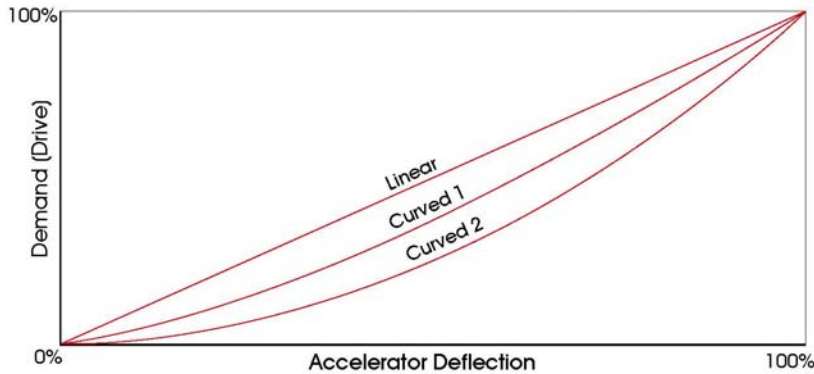

This sets the type of response for both the Accelerator and Footbrake inputs (pins 8 & 9 on Connector A). There are three options for Permanent Magnet Traction control, Linear, Curved1 and Curved2.

The definition of each type is detailed below.

Linear: For input values of 0%, 50% and 100%, the output will be 0%, 50% and 100%.

Curved1: For input values of 0%, 50% and 100%, the output will be 0%, 40% and 100%.

Curved2: For input values of 0%, 50% and 100%, the output will be 0%, 25% and 100%.

There are 9 programmable options; the effect of each is shown below.

- 0: Accelerator = Linear Footbrake = Linear
- 1: Accelerator = Curved 1 Footbrake = Linear
- 2: Accelerator = Curved 2 Footbrake = Linear
- 3: Accelerator = Linear Footbrake = Curved 1
- 4: Accelerator = Curved 1 Footbrake = Curved 1
- 5: Accelerator = Curved 2 Footbrake = Curved 1
- 6: Accelerator = Linear Footbrake = Curved 2
- 7: Accelerator = Curved 1 Footbrake = Curved 2
- 8: Accelerator = Curved 2 Footbrake = Curved 2

I.2 Not Used

Not used.

I.3 Proportional Braking – (Bpro/Off)

This sets how the strength of the direction regenerative braking is controlled.

There are two programmable options – 0 and 1.

If set to 0 (Proportional), the regenerative braking current corresponds to the Accelerator potentiometer position. At the minimum Accelerator potentiometer position, the braking current will be a minimum of 50A, while at the maximum Accelerator potentiometer position, the braking current will be as set by the parameter, 1.9 Direction Regen. Braking. Between minimum and maximum deflection, the braking current will be proportional to the Accelerator potentiometer position.

If set to 1 (Fixed or 'Off'), the regenerative direction braking current is as set by the parameter, 1.9 Direction Regen. Braking, regardless of Accelerator potentiometer position.

I.4 Anti Roll-back (Restraint) – (Arol/Off)

This sets whether there is a restraint function when the vehicle is at rest.

There are two programmable options – 0 and 1.

If set to 0 (Restraint), then the controller will limit the coasting speed of the vehicle. Following neutral braking and omitting any programmed neutral brake end delay, the vehicle will enter and remain in Anti Roll-back mode. Whilst in this mode, the vehicle will be restrained, i.e. rolling speed will be limited.

If set to 1 (Coast or 'Off'), then there is no restraint function and the vehicle is free to coast after any programmed neutral brake end delay.

I.5 Connector A Pin 5 and 6 – (Spd/Inch)

This sets the function of the input pins 5 and 6 on Connector A.

There are two programmable options – 0 and 1.

If set to 0 (Speed Limit), then the inputs can be used to limit the speed of the vehicle via the parameters, 1.6 Speed Limit 1 and 1.7 Speed Limit 2.

If set to 1 (Inching), then the inputs can be used to "inch" the vehicle. In this case, the function of parameters 1.6 and 1.7 will become, 1.6 Inching Speed and 1.7 Inching Time.

Both pins are normally closed inputs.

I.6 Connector A Pin 7 – (Spd3/Hbk)

This sets the function of input pin 7 on Connector A.

There are two programmable options – 0 and 1.

If set to 0 (Speed Limit 3), then the input can be used to limit the speed of the vehicle to a level set by the parameter, 1.8 Speed Limit 3. The limit will apply when a switch connected to pin 7 of Connector A is open.

If set to 1 (Handbrake), then the input can be used to limit the speed of the vehicle to a level set by the parameter, 1.8 Speed Limit 3. The limit will apply when a switch (normally the Handbrake switch), connected to pin 7 of Connector A is closed.

I.7 Power Steering Trigger – (PsF/FR/S)

This sets the trigger source for the power steer contactor. When the vehicle has stopped driving, a timer sets a delay for the power steering to remain active. The length of the delay is set by the parameter, 1.19 Power Steering Delay.

There are three programmable options – 0, 1 and 2.

If set to 0 (Footswitch), then the power steer contactor is driven at the instant the Footswitch (Connector A pin 3), is closed.

If set to 1 (Forward/Reverse), then the power steer contactor is driven at the instant either the Forward Switch (Connector A pin 1) or the Reverse Switch (Connector A pin 2), are closed.

If set to 2 (Seat), then the power steer contactor is driven at the instant the Seat Switch (Connector A pin 4), is closed.

I.8 Truck Type Select (Ride/Wlk)

This sets the function of the input pins 3 and 4 on Connector A.

There are two programmable options – 0 and 1.

If set to 0 (Ride-on), then pin 3 will be a Footswitch input and pin 4 will be a Seat Switch input.

If set to 1 (Walkie), then pin 3 will be a Belly Button input and pin 4 will be a Tiller Switch input.

I.9 Not Used

Not used.

I.I0 Display Error Indication – (Of/M/M&W)

This sets the type of errors that are displayed on the Sigmagauge, if fitted.

There are three programmable options – 0, 1 and 2.

If set to 0 (None), only 'Hard' errors will be displayed on the Sigmagauge.

If set to 1 (Main), both 'Hard' and 'Main' errors that prevent driving will be displayed on the Sigmagauge.

If set to 2 (Main and Warning), all errors – 'Hard', 'Main' and 'Warning' (which do not prevent driving), will be displayed on the Sigmagauge.

I.I1 Display Status Field – (Of/D/V/K)

This sets the type of information that will appear in the General Indication Field of the Sigmagauge, if fitted.

There are five programmable options – 0, 1, 2, 3 and 4.

If set to 0 (None), then the General Indication Field will be blank.

If set to 1 (Accelerator), then the Accelerator deflection as a percentage will be displayed, from 0% to 100%.

If set to 2 (Motor), then the motor speed in units of '%V' will be displayed, from 0 to 100%.

If set to 3 (Speed), then the vehicle speed in units of 'kph' will be displayed, from 0 to the value set in 1.27 Max. Vehicle Speed. (If 1.27 is set to zero, then no speed will be displayed in the General Indication Field).

If set to 4 (Steering), then the vehicle's steering angle will be displayed using crosshairs.

I.I2 Not Used

Not used.

I.I3 Motor Temperature Sensor Type – (MtempTyp)

This sets the type of motor temperature sensor that the controller will interface to via pin 4 of Connector C.

There are 2 programmable options but at present all PM Traction units should have this parameter set to '0'.

The input should be connected to a Philips, KTY81-220 thermistor (PTC 2K @ 25°C), used with an external 2K2 pull-up resistor to +5V.

I.I4 Analogue Inputs Set-up – (Accel 8/9)

This sets the function of input pins 8 and 9 on Connector A.

There are three programmable options – 0, 1 and 2.

If set to 0, then pin 8 will be the Accelerator input and pin 9 will be the Footbrake input.

If set to 1, then pin 8 will be the Footbrake input and pin 9 will be the Accelerator input.

I.I5 Single / Dual Motor Select – (Si/DL/DR)

This sets the function of the input associated with pin 4 on Connector C and whether a controller is the left or right hand unit in a dual motor system.

There are three relevant programmable options – 0, 1 and 2.

If set to 0 (Motor Temperature), then the input can be used to reduce the controller's current output as the motor temperature rises. The relationship between controller output and motor temperature is set by the parameter 4.1 Motor Temperature Cutback.

If set to 1 (Dual Motor Left), then the input can be used to connect to the vehicle's Steering potentiometer, which will feed back the angle of the steered wheels. The controller will be assigned as the left hand unit.

If set to 2 (Dual Motor Right), then the input can be used to connect to the vehicle's Steering potentiometer, which will feed back the angle of the steered wheels. The controller will be assigned as the right hand unit.

When a Dual Motor selection is made, the speed when steering will change as described by the parameter 1.35 Dual Motor Speed in the Adjustments chapter.

I.16 Not Used

Not used.

I.17 CAN Node Number – (CAN node)

The sets the CAN node number for the controller.

There are sixteen programmable options – 0 to 15.

If set to 0 (Master), then this controller is responsible for the following:

- General Indication Field as described in 3.11 Display Status Field.
- BDI information for the Sigmagauge.
- BDI information to all other controllers (slaves), attached to the CANbus.
- Device, fault icon and pulsing information to the Sigmagauge.

If set from 1 to 15, the controller will be a slave.

In multiple controller systems, it is essential that all CAN nodes have a unique number. A slave uses the BDI from the master so disregards it's own BDI and associated settings 1.28, 1.29 & 1.30. However, the BDI cut-out levels, 1.31 and BDI speed, 1.32, still apply. In this way the BDI is equal to all devices on the CANbus, while each controller can set up it's own cut-out and speed levels. All slaves also send out their device, fault code icon and pulsing information to the Sigmagauge.

In a non-CANbus system, the controller(s) should have this parameter set to 0. This is particularly important if the BDI is used. As detailed above, the BDI will not work when set up as a slave controller.



To set the CAN node number in a controller, it must be disconnected from the CANbus.



CHAPTER 5 – MOTOR SET-UP

I Motor Set-up

Ref.	Parameter	Programmer Text
4.1	Motor Temperature Cutback	TempStrt
4.2	Motor to Vehicle Speed Ratio	SpdRatio
4.3	Number of Teeth	SpdTeeth
4.4 – 4.29	Not Used	- n/a -
4.30	Current Threshold	CurrTh
4.31	Lower Maximum Current	lmaxLow
4.32	Threshold Timer	lthTime
4.33	Offset M1, (Applicable in Reverse Drive)	Oset1R +
4.34	Offset M2 (Not Applicable)	- n/a -
4.35	Offset M3, (Applicable in Forward Drive)	Oset3F +
4.36	Gain M1, (Applicable in Reverse Drive)	Gain1R
4.37	Gain M2 (Not Applicable)	- n/a -
4.38	Gain M3, (Applicable in Forward Drive)	Gain3F

I.1 Motor Temperature Cutback – (TempStrt)

This sets the point at which the controller will begin to reduce its drive current output, in order to protect the motor. The temperature is measured by the motor’s thermal sensor, which provides feedback via pin 4 of Connector C. The output will reduce linearly to zero at a point set by the value of this parameter plus 10°C.

The adjustable range is 1°C to 151°C in 1°C steps.

If set to 151°C, then the function will be disabled and no reduction in current will occur.

I.2 Motor to Vehicle Speed Ratio – (SpdRatio)

This sets the relationship between the rotational speed of the motor and the actual driving speed of the vehicle, i.e. the overall vehicle gear ratio. This information, in conjunction with parameter, 1.27 Max. Vehicle Speed, is used to set the speed display on the Sigmagauge.

The value of this parameter should be the result of dividing the motor’s speed in units of rpm by the vehicle’s speed in units of kph.

Example: if a vehicle speed of 15kph corresponds to a motor speed of 3000rpm, then the value of this parameter should be $3000/15 = 200$.

The adjustable range is 1.0 to 999.9 in 0.1 step increments.

I.3 Number of Teeth – (SpdTeeth)

This sets the number of pulses, i.e. teeth on the encoder that correspond to one motor revolution.

The adjustable range is 1 to 255 in 1 step increments.



After the value has been changed, the keyswitch must be cycled for the new value to be accepted.

I.4 – I.29 Not Used

Not used.

:: Timed Current Limit Explained ::

The following graph shows the parameters that are involved in setting up the Timed Current Limit. This feature can be used to protect the vehicle’s motor(s) from overheating.

If the current rises above a set threshold for a specified period of time, the controller can reduce the maximum current available to the motor(s). After the reduction has occurred, the maximum current output will remain at the lower level for a period of 3 times the ‘threshold time’. If necessary, once this period has expired, the current can then be returned to its original level.

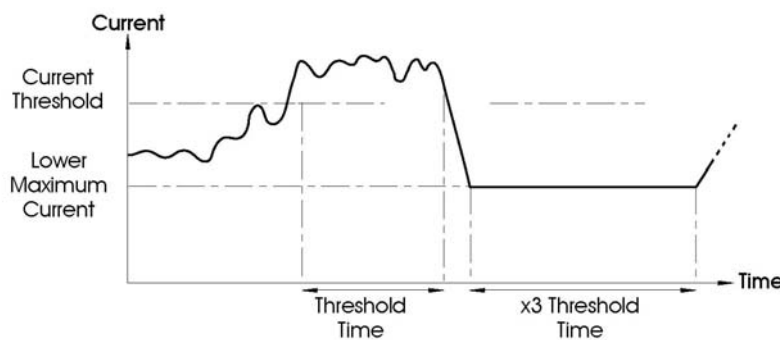

I.30 Current Threshold – (CurrTH)

This sets the level of current, which if exceeded, will activate 4.32 Threshold Timer.

The adjustable range is 50A to the maximum rating of the controller in 10A steps.

I.31 Lower Maximum Current – (ImaxLow)

This sets the value of the reduced current available to the motor(s), once the 4.32 Threshold Timer period has elapsed.

The adjustable range is 50A to the maximum rating of the controller in 10A steps.

I.32 Threshold Timer – (lthTime)

This sets the period of time, which if exceeded, will initiate a reduction in the controller's maximum current output. A programmed value of zero disables the Timed Current Limit feature.

The adjustable range is 0s to 60s in 1s steps.

Example: 4.30 Current Threshold is set to 600A.
4.31 Lower Maximum Current is set to 450A.
4.32 Threshold Timer is set to 10s.

If the motor current is above 600A for 10 seconds, then the controller will reduce the maximum current available to 450A for a period of 30 seconds (3 x 10 secs).

There are maximum permissible values, which must not be exceeded, for each of these parameters. These values are shown in the table below.

	Maximum Drive Current	Current Threshold	Threshold Timer	Lower Maximum Current
PMT835M	350A	350A	60s	350A
PMT465L	650A	650A	60s	650A
PMT445M	450A	450A	60s	450A
PMT425S	250A	250A	20s	250A



The values in the table above should never be exceeded.

I.33 – I.38 Offset and Gain Settings

These parameters are factory settings and should not be altered under any circumstances.



CHAPTER 6 – HAND-HELD PROGRAMMER

I Introduction

The Sigmadrive Hand-held Programmer is a powerful tool that can be used to configure all Sigmadrive controllers as well as the Sigmagauge display. In addition to multiple programming menus, there are status and test functions with powerful, real-time system information, making set-up or diagnosis particularly intuitive. The Programmer also has an interface for updating the controller's flash memory, as well as updating the Programmer's own software.

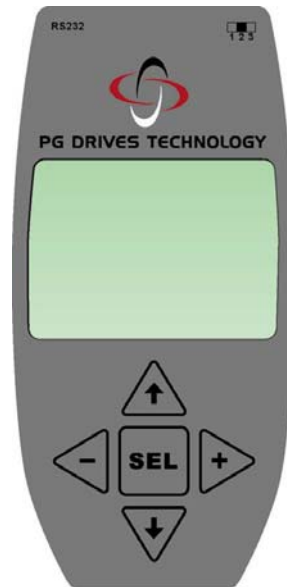

II Interface Switch

On the top-right-hand side of the Programmer, there is a 3-way switch that is used to select the operating mode of the Programmer.



For normal Sigmadrive programming and diagnostics, this switch must be set to position 2.

Positions 1 and 3 are for Sigmadrive and Programmer software upgrades. Refer to the section Software Upgrades later in this manual for more details.

2 Connection

The Programmer is generally connected to a Sigmadrive, via the controller's 8-way Connector B.



The exact method of connection of the Programmer will depend on how many Sigmadrive controllers are fitted to the vehicle being programmed.

If there is just one Sigmadrive, then connect the Programmer directly to Connector B on that controller.

If there is more than one Sigmadrive fitted, but these are not connected to each other via their CANbus, then program each controller separately.

If there is more than one Sigmadrive fitted and they are linked via their CANbus connections on Connector B, then it will be necessary to use an adaptor to provide a spare connection point for the programmer. In this instance, it will also be necessary to initially give each controller a unique CAN node number, see section CAN Node Set-up below.

The Programmer can be connected and disconnected at any time, regardless of whether the controller is on or off.

2.1 CAN Node Set-up

If the vehicle you are programming has multiple Sigmadrive controllers, connected via CANbus, then the Programmer will automatically scan the bus for all available CANbus nodes. Each CANbus node is identified by a number and the factory default for each controller is 0. Therefore, before undertaking any programming, each controller should be given a unique node number. To do this, disconnect the CANbus from each Sigmadrive, then connect the Programmer directly to each controller in turn and set the unique number. This is done via the programmable parameter, 3.17 CAN Node Number, in the Controller Set-up menu.

3 Using the Programmer

The Programmer has five buttons. The function of each is explained below.



This button is used to scroll up the on-screen menu.



This button is used to scroll down the on-screen menu.



This button is used to select a highlighted menu item, and to return to the main menu.



This button is used to decrement the value of a highlighted parameter.



This button is used to increment the value of a highlighted parameter.

4 Programmer Map

The Programmer has a menu structure that allows smooth and swift parameter adjustments, as well as system diagnostics and testing.

Upon initialization, the Programmer will display the 'Calibrator' screen, as shown below, which prompts you to select the controller type. (AC Traction is shown in this example). Once the controller type is selected, there are then programming, diagnostic and test options available.

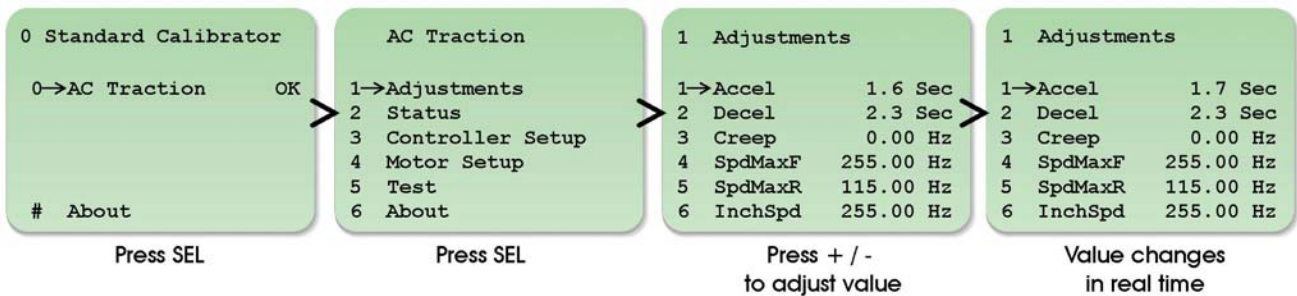

Some parameters e.g. 3.8 Truck Type Select, require that the power to the controller be cycled via the keyswitch before the new value will be accepted. These parameters are marked on the Programmer's screen with the word 'Key'.

4.1 Programming, Diagnostic and Test Options

4.1.1 Adjustments

This menu includes parameters related to the application's performance, such as acceleration, speeds and BDI calibration. Refer to the Adjustments chapter for full details.

4.1.2 Status

This menu allows you to select system and controller information for display, such as vehicle speed, battery voltage and controller temperature. Refer to the Diagnostics chapter for full details.

4.1.3 Controller Set-up

This menu includes parameters related to the controller's operation, such as I/O configuration; throttle response and CAN node set-up. Refer to the Controller Set-up chapter for full details.

4.1.4 Motor Set-up

This menu includes parameters specifically related to the type of motor being used. Refer to the Motor Set-up chapter for full details.

4.1.5 Test

This menu allows you to select controller I/O status for display, such as the state of digital and analogue inputs, or contactor and LED outputs. Refer to the Diagnostics chapter for full details.

4.1.6 About

This menu option displays information about the system. The information is factory programmed into the controller by PGDT and is displayed as follows.

Cal Ref	Information Field	Example	
1	Customer Name	Cust	Standard
2	Application	App	Standard
3	Motor Type	Motor	PM
4	Controller Type	Type	PPM835TM01
5	Hardware Voltage and Current	HW	80V 350A
6	Software Version	SW	3.01.00 150107

5 Diagnostics

If the controller has detected an error, this will be displayed as a number (preceded by 'F'), on the right-hand side of the Controller Type screen, as shown below.

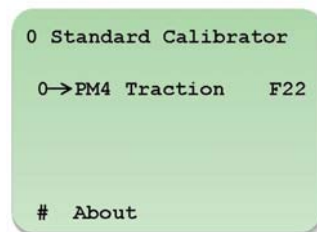

In this instance, the error code is '22'. For details of this error, refer to the Diagnostics chapter.

6 Software Upgrades

The Programmer can be used to load revised software into the controller. Likewise, the Programmer's own software can be revised.

If either of these operations is required to be undertaken, PGDT will supply more detailed and specific instructions.



CHAPTER 7 – SIGMAGAUGE

I Introduction

The Sigmagaugue LCD is a highly versatile backlit, dot-matrix display, which presents vehicle status and diagnostic information to the operator, using clear, easy-to-read icons.

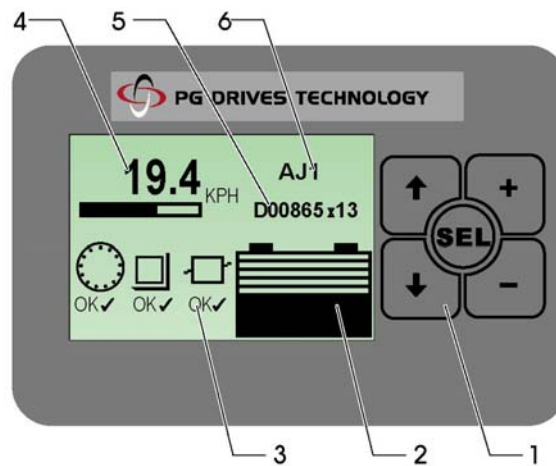

II General Information

II.1 Membrane Buttons

These are used for navigating and setting parameters in the Gauge Set-up menu.

II.2 Battery Discharge Indicator

Indicates the battery discharge state as set by CAN Node 0 (Master).

II.3 Fault Indication Field

Indicates the status of all Sigmadrive controllers in the system. A number is displayed within a 'traction', 'pump', 'steering wheel' or 'CAN I/O' icon to indicate which controller is experiencing a problem. When a fault is detected, the 'OK' symbol below the CAN node indicator, is replaced with a fault icon (see Diagnostics chapter). The value of 3.10 Display Error Indication, determines which failure types are displayed or ignored.

II.4 General Indication Field

The information shown in this area of the Sigmagaugue is determined by the value set in 3.11 Display Status Field. Options are none, accelerator demand, motor speed, vehicle speed and steering angle.

II.5 Hours Counter

Indicates either 'work' (drive) or 'key' hours & minutes, selectable in the Gauge Set-up menu. The hours counter value is stored in the display. The controllers have their own separate counter.

II.6 Information Field

A 2x9 character field to show customized text, e.g. vehicle OEM and type. The membrane buttons can be used in the Gauge Set-up menu to edit the text displayed.

2 Connection

The Sigmagaugue is connected to the Sigmadrive, via the controller's 8-way Connector B.

The PGDT part number for the 'Sigmagaugue' mating connector is D51069.

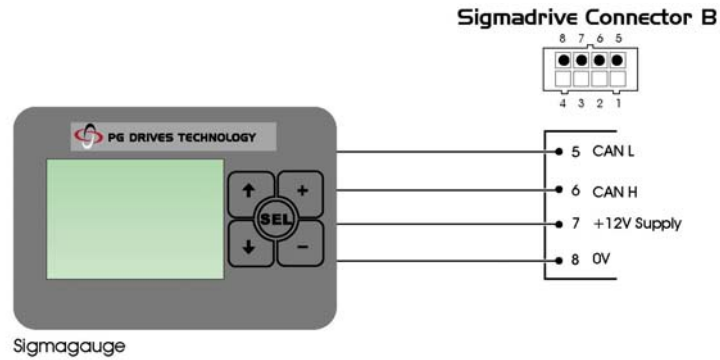

3 Mounting

Mounting the Sigmagaugue module requires a rectangle to be cut into the vehicle dashboard, allowing the module to rest on the surface of the dash.

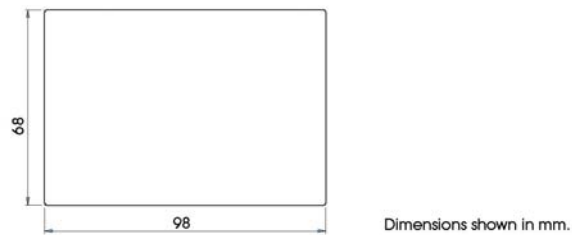

Before cutting the hole, ensure that enough room is available within the dash for the area of the module and the Securing Bracket. Access to the back of the dash will be required to secure the Sigmagaugue.

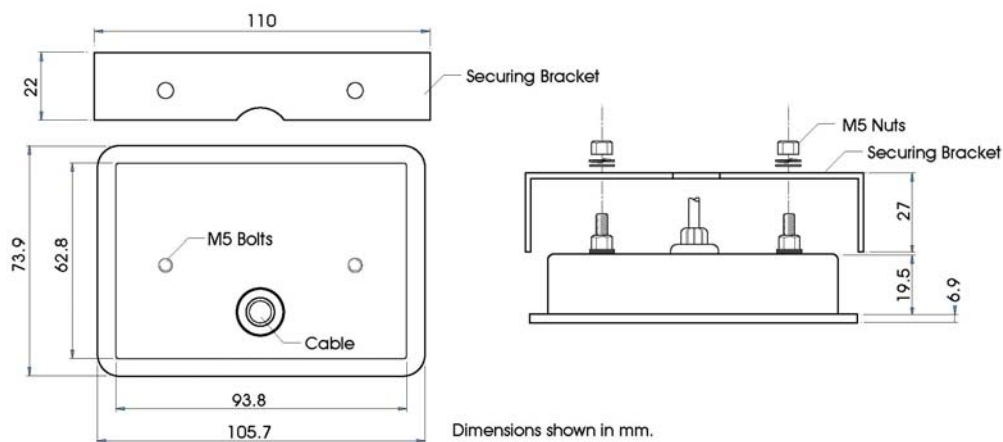

- Once the cut-out is ready, ensure that all debris is removed and the surface is clean.
- Place the Sigmagaugage in the hole.
- Raise the Securing Bracket from beneath the dash surface and locate onto the mounting bolts.
- Once located, fasten using the M5 nuts supplied.



To maintain a good weather seal, it is suggested that a waterproof adhesive is used to seal and secure the Sigmagaugage to the dash.

4 Configuring the Sigmagaugage

To access the Gauge Set-up menu, press and hold the 'SEL' button for 3 seconds. Features such as the Service Interval Timer, Hours Counter and Text Field can be adjusted and optionally protected with a pin code. Use the up and down arrow buttons to choose an option, 'SEL' to select an option and the '+' & '-' buttons to amend the current value.

The table below shows the structure of the Gauge Set-up menu. It describes the action and range of each available parameter.

Ref.	Parameter	Sub Menu Reference	Sub Menu Description	Range & Action
1	Service timer	1. Svc interval	Set the time interval for the next service	0 – 32767 Hrs. (Warning starts 40 hours before service required)
		2. Count hours	Set to count 'work' (drive) or 'key' hours	Work / Key Hrs.
		3. Reset timer	Resets the Service Timer (sub menu ref '4')	To confirm, press 'SEL'
		4. Svc time	Indication of the actual counter value	Indication only
2	Hours counter	1=Key, 2=Work	Select to indicate 'work' or 'key' hours	Select with up & down arrows and confirm with 'SEL'
3	Information field	1. Adjust field	Free 2x9 character field to show customized text	Use up and down arrows for position, '+' & '-' to change value and 'SEL' to return to menu
4	Pincodes	1. Service timer	Sets pin code for service timer access	Contact PGDT
		2. Information field	Sets pin code for information field access	
		3. Reset all pincodes	Reset all pin codes	
5	About	SW version and date	Indication of the software version and date	Indication only
6	Return	-	Select to return to main menu	Select with up & down arrows and confirm with 'SEL'



CHAPTER 8 - TECHNICAL SPECIFICATIONS

I Electrical

I.1 Voltage Specifications

Model	Voltage	Nominal Battery Voltage	Absolute Operating Voltage Range
PMT4xxX	48V Units	24-48V	14.5 – 61.0V
PMT8xxX	80V Units	72-80V	43.0 – 98.0V

I.2 Current Specifications

Model	Voltage	Maximum Current (rms) / Time	Continuous Current (rms) – 1 Hour
PMT425S	48V	250A / 20s	80A
PMT445M	48V	450A / 60s	180A
PMT465L	48V	650A / 60s	260A
PMT835M	80V	350A / 60s	120A

Switching Frequency: 14.5 KHz.

Electrical Isolation: Enclosure to any live part = 1KV. Controller internal insulation specified at >10MΩ @500V DC.

2 Environmental

Ingress Protection (IP): The enclosure is protected to IP54 (varnished PCB).

Vibration: 6G, 40-200Hz for 1 hour, in x, y and z planes.

Operating Temperature: -30°C to +40°C ambient around controller.

Storage Temperature: -40°C to +70°C.

Humidity: 95% maximum, non-condensing.

3 Mechanical

Dimensions:	Refer to frame drawings in Installation chapter.
Enclosure:	Aluminium heatsink with ABS plastic cover.
Recommended fixing torques:	Large and Medium frame – 11Nm Small frame – 9Nm.
Maximum screw thread penetration depth:	All frame sizes – 14mm.
Weight:	Small: 1.2Kg; Medium: 4.1Kg; Large: 6.1Kg.



Always use a torque screwdriver when fixing the power terminals.



Exceeding the maximum specified torque can cause serious damage to the controller and warranty may be void.



Screws that are too long will damage the controller.